

Biology

1983-2004

JAMB
Questions

Biology 1983

1. Root hairs are developed from the ...
 A. root apex B. epidermis of roots
 C. vascular bundles D. endodermis
 E. pericycle

Use Fig. 1 to answer questions 2-4
 Fig 1

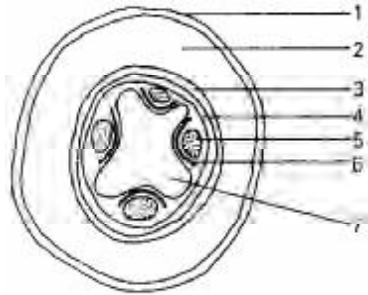

Fig 1 represents a cross-section of a part of a dicot plant.

2. Which of the following features can be used to identify Fig 1?
 A. Position of 7 B. Its circular nature C. Number of 5
 D. Presence of 3 E. Width of 2.
3. The main function of 6 is to
 A. separate 5 from 7 B. produce more of 5 and 7.
 C. produce cork D. translocate water and mineral salt
 E. conduct carbon dioxide to the other parts.
4. The main function of 4 is to
 A. surround the inner tissues B. produce cork
 C. produce root hairs D. produce lateral roots
 E. produce more of 3.
5. In a dicot leaf, guard cells differ from other epidermal cells because they
 A. have no definite shape B. lack nuclei
 C. are smaller D. contain chloroplasts E. lack vacuole.
6. Which of the following structures is NOT found in the female agama lizard?
 A. Pre-anal pads B. Eardrum C. Gular fold
 D. Nasal scale E. Nuchal crest.
7. Herbs differ from shrubs because they
 A. do not produce fruits B. are useful to herbalists
 C. do not become woody D. are only annuals E. are only perennials.
8. If an isolated living cell is left in distilled water for two hours, it is likely to
 A. lose some of its water to the surrounding water
 B. lose all of its water to the surrounding water
 C. reproduce by binary fission D. become more turgid.
 E. die due to excess water.
9. If an organic compound has its Hydrogen: Oxygen ratio as 2:1, it is likely to be

- A. a protein B. a carbohydrate, C. a fat
 D. a fatty acid and glycerol E. an amino acid.

10. Which of the following elements are necessary for the formation of chlorophyll in a plant?
 A. Magnesium and iron B. Calcium and potassium
 C. Calcium and sulphur D. Potassium and sulphur
 E. Phosphorus and potassium.
11. Which of the following statements is NOT true of mammalian erythrocytes?
 A. They have haemoglobin B. They appear yellow when looked at singly
 C. They are disc-shaped
 D. The cells are more numerous than leucocytes
 E. They have nuclei at maturity.
12. In woody plants, gases and water vapour are transported across the stems by the
 A. xylem fibres B. medullary fibres C. medullary rays
 D. phloem fibres E. phloem parenchyma.
13. Which of the following substances is NOT found in urine?
 A. Water B. Sodium chloride C. Nitrogenous compounds
 D. Calcium chloride E. Nitrogenous salts.
14. The kidneys of all vertebrates act as osmo regulators. This means that they
 A. keep the composition of the plasma constant
 B. regulate osmotic processes C. Control the volume of blood entering the kidneys
 D. decrease the osmotic pressure of blood E. increase the osmotic pressure of blood.
15. The movement of part of a plant in response to external stimulus of no particular direction is
 A. taxis B. tropism C. haptotropic movement
 D. nastic movement E. phototropism
16. The part of the mammalian brain responsible for maintaining balance is the
 A. medulla oblongata B. olfactory lobe
 C. cerebellum, D. cerebrum E. frontal lobe.
- 17.

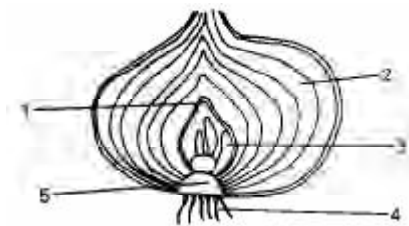

Fig vertical section of onion bulb.

Which of the labelled parts in Fig 2 will develop into a new bulb? A. 1 B. 4 C. 2 D. 3 E. 5.

18. In the onion bulb, food is stored in the
 A. stem B. lateral buds C. cotyledons
 D. outer scale leaves E. leaf bases.

19. Groundnut is not really a 'nut' in the biological sense because
 A. it is harvested from inside the ground B. its pericarp is not hard and tough. C. the fruit is succulent
 E. it is an achene.
20. What type of fruit is formed from a single flower having several free carpels?
 A. multiplefruit B. Simplefruit C. Aggregate fruit
 D. Dehiscent fruit E. Indehiscent fruit.
21. A 28g soil sample was heated to a constant weight of 24g. When further heated to red hot and cooled, it weighed 18g. What is the percentage of humus in the soil?
 A. 22.2 B. 55.6 C. 75.0 D. 25.9 E. 35.7.
22. Which of the following diseases is NOT caused by a virus?
 A. Rinderpest B. Maize rust C. Newcastle disease
 D. Swine fever E. Cassava mosaic disease.
23. A centipede differs from a millipede by its
 A. colour B. numerous abdominal segments
 C. paired legs on each abdominal segment
 D. poison claws E. cylindrical body.
24. An organism having one pair of identical genes is
 A. a heterozygote B. a hybrid C. an allelomorph
 D. a homozygote E. a diploid
25. Plants which can survive in places where the water supply is limited are
 A. bryophytes B. mesophytes C. xerophytes
 D. hydrophytes E. pteridophytes.
26. Banana, plantain and pineapple can be grouped together because they
 A. produce small seeds B. are multiple fruits
 C. produce suckers D. have runners E. have bulbils.
27. One disease NOT caused directly by bacteria is
 A. malaria B. tuberculosis C. pneumonia D. tetanus
 E. cholera.
28. In what order do the following structures develop during the metamorphosis of the toad? 1. External gills 2. Internal gills 3. Forelimbs 4. Hindlimbs 5. Mouth.
 A. 1 2 3 4 5 B. 1 5 2 4 3 C. 1 3 4 5 D. 5 3 4 1 2
 E. 5 4 3 2 1.
29. The dental formula $i \frac{3}{3}; c \frac{1}{1}; pm \frac{4}{4}; m \frac{2}{3} = 42$ represents that of a
 A. rabbit B. full grown man C. young child
 D. dog E. sheep.
30. Which of the following statements is NOT true of insectivorous plants?
 A. They obtain part of their food by trapping and feeding on insects B. They attract insects simply because of pollination. C. They can grow in soils poor in nitrogenous salts. D. They can supplement the nitrogen supply by feeding on insects E. Examples include butterworts, sundews and pitcher plants.
31. Which of these worms is beneficial to man?
 A. Hookworm B. Tapeworm C. Roundworm
 D. Earthworm E. Guinea worm.
32. Starting from the skull end, the vertebrae are arranged in the following order:
 A. axis, atlas, cervical, thoracic and lumbar
 B. atlas, cervical, axis, thoracic and lumbar
 C. atlas, axis, thoracic, cervical and lumbar
 D. atlas, axis, cervical, thoracic and lumbar
 E. atlas, thoracic, cervical axis and lumbar.
33. Which of the following diseases could be exclusively associated with a river basin?
 A. Malaria B. Syphilis C. Onchocerciasis
 D. Cholera E. Poliomyelitis.
34. Which of the following represents the evolutionary sequence in these plants? 1. Flowering plants, 2. Ferns, 3. Mosses, 4. Algae, 5. Conifers.
 A. 2 → 1 → 4 → 3 → 5 B. 5 → 4 → 3 → 2 → 1 C. 2 → 4 → 5 → 1 → 3
 D. 3 → 2 → 4 → 5 → 1 E. 4 → 3 → 2 → 5 → 1
35. Which of the following will NOT allow osmosis to take place?
 A. pig's bladder B. Cellophane C. Parchment paper
 D. Transparent polythene E. Cow's bladder.
36. Which of the following statements on the mammalian circulatory system is Not true?
 A. Blood in the pulmonary artery is richer in oxygen content than blood in the pulmonary vein
 B. The blood in the hepatic portal vein is the richest in food substances. C. Blood flow is controlled by valves in the veins D. Arteries are generally thicker and larger than veins. E. Fibrin helps in the formation of blood clot.
37. In a positive phototropic response of a coleoptile, the region of greatest curvature is brought about by the
 A. movement of auxins away from the region of curvature, B. even distribution of auxins in all parts of the coleoptile, C. inhibition of growth by auxins in the region of smaller curvature
 D. concentration of auxins in the region of curvature E. absence of auxins in the coleoptile.
38. The tuber of cassava is NOT a stem tuber because it
 A. is distended with food reserve B. has an aerial shoot portion C. has other structures that could be called roots D. lacks axillary buds
 E. has a bark over its stored food.
39. The function of the ossicles (malleus, incus and stapes) in the mammalian ear is the
 A. transmission of vibrations B. regulation of pressures C. support of the inner ear
 D. maintenance of balance during motion
 E. secretion of oil.
40. Which of the following instruments is used for determining turbidity of water?
 A. Thermometer B. Secchi Disc C. Rain gauge
 D. Hygrometer E. Wind vane.
41. Which of the following is NOT a characteristic of monocot plants?

- A. occurrence of secondary thickening B. Parallel venation C. Scattered vascular bundles
D. Floral parts arranged in threes, E. Periath is usually insignificant
42. Which sequence represents the correct order of organism in a food chain? 1. Toad, 2. Mucuna, 3. Grasshopper, 4. Snake, 5. Hawk.
A. 5→4→1→3→2 B. 1→2→3→4→5
C. 2→1→3→4→5 D. 2→3→1→5→4
E. 2→3→1→4→5
43. In Rhizopus, carbohydrate is stored in the form of
A. glucose B. paramylon C. glycogen D. starch E. oil
44. Which of the following statements about the rate of transpiration is INCORRECT? It is
A. dependent on temperature B. affected by changes in light intensity C. unaffected by humidity
D. dependent on air movement E. affected by availability of water.
45. 'Jointed skeleton' is absent in the
A. cockroach B. spider C. millipede D. snail
E. dragon fly.
46. Which of the following statements about the definition of man is Incorrect? Man has
A. more molars than incisors B. no diastema
C. the same number of teeth on upper and lower jaws
D. a total of thirty-two teeth E. a total of six molars.
47. When a Spirogyra cell is immersed in a salt solution more concentrated than its cell sap, it
A. remains unchanged B. takes up water and bursts
C. absorbs a little water D. loses water and shrivels
E. becomes turgid.
48. Urea is produced in the
A. liver, B. Ladder, C. spleen, D. kidneys. E. gall bladder
49. What is the genetic ratio of the F₂ generation if members of F generation are allowed to self-pollinate?
A. 1 tall: 3 short B. 3 tall: 1 short C. 1 tall: 1 short
D. 4 shorts: 0 tall E. 4 tall: 0 short
50. The path taken by glucose from the ileum to the heart is
A. ileum → hepatic portal vein → hepatic artery → vena cava → heart. B. ileum → hepatic portal artery → hepatic artery → venacave → heart.
C. ileum → hepatic portal vein → vena cava → heart
D. ileum → hepatic vein vena cava heart.
E. ileum → hepatic portal vein → hepatic vein → vena cava → heart.

Biology 1984

1. The mouth part of the housefly are adapted for
A. lapping and sponging. B. sucking and chewing.
C. piercing and sucking. D. chewing and lapping.
E. biting and chewing.
2. The male toad differs from the female by having
A. vocal sacs. B. shorter hind limbs.
C. longer fore limbs. D. bulging eyes.
E. nictating membrane.
3. Mosses, liverworts and ferns can be grouped together because they
A. are all aquatic plants. B. all grow in deserts.
C. are seedless plants. D. have undifferentiated plant bodies. E. all produce colourless flowers.
4. Spirogyra and Mucor can be grouped together as Thallophyta because.
A. they are unicellular organism B. their spores could be dispersed by wind C. they are capable of living independent lives D. they reproduce sexually only E. their bodies are made up of thallus and filaments alternatively.
5. Which of the following invertebrates does NOT possess antennae?
A. Centipede B. Crustacean C. Millipede
D. Insect E. Spider
6. Which of the following is INCORRECT? The prothallus of a fern
A. is a flattened heart-shaped structure.
B. is green because its cells contain chloroplasts
C. is the dominant plant D. bears the sexual organs
E. is attached to the ground by numerous rhizoids.
7. Which of the following cell constituents is NOT common in both plants and animals?
A. Mitochondria B. Chloroplasts
C. Ribosomes D. Golgi apparatus
E. Vacoules.
8. The character-producing factors in living organisms are
A. chromomeres B. alleles C. chromatids
D. chromosomes E. genes.
9. A mixture of mercurous and mercuric nitrates is added to a food substance. A white precipitate is formed which on gentle heating turns red. The food substance is
A. protein B. oil C. Carbohydrate
D. Fat E. Fatty acid.
10. The mammalian organ through which nourishment and oxygen diffuse into a developing embryo is called
A. amnion B. chorion C. umbilical cord
D. oviduct E. placenta

11. Fig 1 represents a quill feather. The structure labelled "M" is the
 A. quill B. rachis C. superior umbilicus
 D. inferior umbilicus E. aftershaft

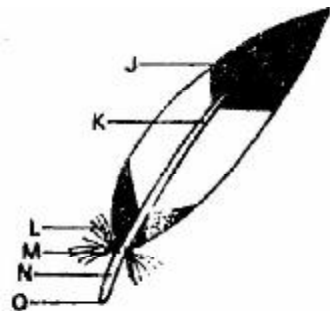

12. Osmosis can be defined as the movement of
 A. molecules from solution of high concentration to low concentration B. molecules from solution of low concentration to high concentration
 C. water from solution of high concentration to low concentration D. Water across a semi-permeable membrane from solution of low concentration to high concentration E. water across a semi-permeable membrane from solution of high concentration to low concentration

13. Which of the following statements is NOT true of enzymes? They
 A. are proteins B. need cofactors to activate them
 C. are sensitive to hydrogen ion concentration
 D. are specific in their action
 E. can withstand high temperatures.

14. The dorsal and anal fins of fish are used for
 A. upward movements B. controlling rolling movements C. downward movements
 D. steering E. buoyancy.

15. Exoskeleton is NOT found in the
 A. maggot B. mosquito larva C. earthworm
 D. caterpillar F. termite

16. Blood clotting is initiated by
 A. leucocytes B. platelets C. haemolymph
 D. haemoglobin E. erythrocytes

17. Pepsin is a digestive enzyme which breaks
 A. cellulose into glucose molecules
 B. carbohydrates into simple sugars
 C. protein into peptones D. fats into glycerol and fatty acids E. sucrose into glucose and fructose.

18. Anaerobic respiration in yeast produces
 A. carbon dioxide and ethanol B. carbon dioxide and water C. carbon dioxide and oxygen
 D. carbon dioxide and glucose E. ethanol and water

19. Underground stems which grow horizontally through the soil are
 A. blubs B. rhizomes C. runners
 D. corms E. stolons

20. A man with a normal haemoglobin (AA) marries a woman who has sickle-cell haemoglobin (SS). They have a child who has sickle-cell trait. Which of the following genotypes could be associated with the child's haemoglobin ?
 A. AA B. OO C. AO
 D. AS E. SS

21. In a Biuret test, some protein was mixed with sodium hydroxide solution. Which of the following chemicals should be added to the mixture for a positive result?
 A. Mercurous nitrate B. Copper sulphate
 C. Mercuric nitrate D. Sodium carbonate
 E. Ammonium hydroxide

22. The removal of a man's pancreas by surgical operation can affect only the digestion of
 A. starch B. starch, protein and fats
 C. oils and fats D. proteins
 E. carbohydrate and fats.

23. The parts used by tapeworm to fasten itself to the host's intestine are the
 A. neck and suckers B. hooks and suckers
 C. rostellum and suckers
 D. young proglottis and neck E. rostellum, hooks and suckers.

Use Fig 2 to answer questions 24 - 25

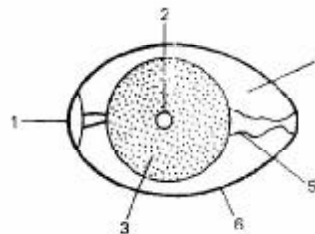

Fig 2. transverse section of a fowl's egg

24. The young chick is formed from
 A. 3 B. 3 and 4 C. 1, 3 and 5 D. 2 E. 4

25. Which parts provide food for the developing chick?
 A. 2 and 3 B. 4 and C. 3 and 4
 D. 2 and 5 E. 1 and 2

26. Which of the following types of vertebrae occur in equal numbers in the rabbit, rat and man?
 A. Caudal B. Thoracic C. Lumbar
 D. Cervical E. Sacral

27. Which of the following statements is NOT true of the piliferous layer of a root? It
 A. has a very thin cuticle B. is the outermost layer of the cortex C. may bear root hairs
 D. breaks down as the root ages
 E. is replaced by cork in old roots.

28. A flowering plant is monoecious if
 A. the androecium is found on one plant
 B. the gynoecium is monocarpous
 C. it produces essential organs D. the gynoecium and androecium are on the same plant
 E. the flowers are unisexual

29. How many nuclei are found in a pollen tube during fertilization?
A. 2 B. 3 C. 5 D. 6 E. 7
30. Which of the following is NOT a waste product of plants?
A. Tannin B. Oxygen C. Carbon dioxide
D. Sap E. Alkaloids
31. If an animal is very active and has good muscular control, it is likely to have well-developed
A. olfactory lobes B. cerebral hemispheres
C. optic lobes D. cerebellum E. spinal cord
32. Which of the following adaptations is NOT concerned with the flight of birds?
A. Streamlined shape B. Presence of powerful muscles
C. Reduced body weight D. Broad sternum
E. Webbed feet.
33. The transect method can be used in ecology to show the
A. number of plants and animals in a habitat
B. population of a plant species
C. distribution of organisms along a line
D. heights of trees in a section of a forest
E. number of young plants across a forest.
34. Asexual reproduction does NOT occur in
A. Mucor, Spirogyra and Paramecium
B. Penicillium, Paramecium and Amoeba
C. Mucor, Rhizopus and penicillium
D. Amoeba, spirogyra and Mucor
E. Rhizopus, Ascaris and Amoeba.
35. Fehling's solution will readily change colour from blue to a reddish colour when it is
A. mixed with sugar solution in the cold
B. warmed or heated by itself
C. mixed with reducing sugar in the cold
D. warmed or heated with a complex solution
E. warmed with a solution of reducing sugar.
37. Normally the flow of blood is NEVER from
A. artery to arterioles B. arterioles to capillaries
C. capillaries to venules D. arterioles to the artery
E. venules to the vein
38. Heat produced in tissue respiration in plants is
A. a chemical form of energy B. the only form of energy
C. the main form of energy D. a useful form of energy
E. a waste form of energy.
39. The axial skeleton of a mammal does not include the bones of the
A. skull B. tail C. limbs D. back E. neck.
40. Which of the following sequences represents the process of blood clotting? 1. Fibrin forms a network of threads 2. Red blood cells are caught and a clot is formed 3. Fibrinogen in plasma changes into soluble fibrin 4. Blood is exposed to air.
A. 4,3,2,1 B. 4,3,1,2 C. 3,1,4,2 D. 1,2,3,4
E. 3,1,2,4.
41. Green plants are important in the ecosystem because they are
A. primary consumers B. producers
C. decomposers D. secondary consumers
E. scavengers.
42. An anemometer is an instrument for measuring
A. relative humidity B. altitude C. wind speed
D. turbidity E. salinity.
43. Which of the following is NOT regarded as a pollutant on land or in the air?
A. Noise B. Smoke C. Sulphur dioxide
D. Carbon monoxide E. Nitrogen
44. Which of the following groups of factors is completely abiotic?
A. salinity, tide, plankton, turbidity
B. Temperature, pH, soil insect
C. Wind, altitude, humidity, light
D. Conifers, winds, pH, rainfall
E. Soil, water, bacteria, salinity
45. Which of the following lists of diseases, their causes and transmission is CORRECT?
A. Cholera, virus, severe diarrhoea, infected water.
B. Malaria, protozoan, high fever, contact with infected person
C. Syphilis, virus, venereal disease, sexual intercourse
D. Smallpox, virus, skin with blister, close contact with infected person.
E. Sleeping sickness, bacteria, tiredness, headaches and dozing, tsetse fly bite
46. Erosion can be reduced along a slope by
A. ridging across slope B. ridging up slope
C. ridging down slope D. crop rotation
E. bush fallowing system.
47. If a handful of soil is shaken with water and left to settle, the soil particles will settle from light to heavy particles as follows:
A. humus, clay, silt, sand, stones B. humus, silt, clay, sand, stones
C. humus, clay silt, stones, sand
D. humus, sand, silt, clay, stones
E. clay, humus, silt, sand, stones.
48. Denitrifying bacteria in nature liberate gaseous nitrogen directly from
A. ammonium salts B. soil nitrates
C. thunderstorms D. soil nitrites
E. plant and animal proteins.
49. Leaching is
A. washing away of humus from the soil surface
B. reduction of soil aeration by pressure
C. soil erosion by means other than rainfall
D. loss of organic matter due to exposure to direct sunlight
E. washing out of chalk and limestone from upper layers of soil by heavy rains
50. The process of soil erosion is usually from
A. rill → sheet → gully B. gully → rill → sheet
C. sheet → gully → rill D. sheet → rill → gully
E. rill → gully → sheet

Biology 1985

1. In Spirogyra, the pyrenoid
 - A. excrete waste products
 - B. is suspended by cytoplasmic strands
 - C. is mainly used for respiration
 - D. usually contains starch
 - E. makes the plant slimy to touch.
2. In which of the following groups of animals are flagella and cilia found?
 - A. Flatworms
 - B. Annelids
 - C. Coelenterates
 - D. Protozoa
 - E. Nematodes
3. Which of the following is seed bearing?
 - A. Mosses
 - B. Whistling pine
 - C. Algal filaments
 - D. Livewort
 - E. Fern fronds.
4. Each of the following is an arthropod EXCEPT the
 - A. crab
 - B. spider
 - C. snail
 - D. millipede
 - E. cockroach
5. In fish the sense organs which detect movements in the water are located within the
 - A. gills
 - B. operculum
 - C. nostrils
 - D. median fins
 - E. lateral line.
6. Euglena is an autotrophic organism because it
 - A. has flagella
 - B. has plant and animal features
 - C. is found in water
 - D. can manufacture its food
 - E. moves fast.
7. Which of the following is **NOT** true of Mucor? It
 - A. contains chlorophyll
 - B. grows saprophytically
 - C. bears spores in sporangium
 - D. consists of hyphae
 - E. reproduces by conjugation
8. Bryophytes are different from flower because they
 - A. live in moist habitats
 - B. are small plants
 - C. reproduce sexually and asexually
 - D. have small leaves
 - E. have no vascular tissues.
9. At what stage in the life history of a toad is its mode of breathing similar to that of a fish?
 - A. Tadpole stage
 - B. External gill stage
 - C. Adult stage
 - D. Internal gill stage
 - E. Larval stage.
10. In lower plants like mosses, the structure which performs the functions of roots of higher plants is called
 - A. root hairs
 - B. rootlets
 - C. hyphae
 - D. rhizoids
 - E. thalli.
11. In an angiosperm leaf, the xylem is
 - A. beside the phloem
 - B. surrounded by the phloem
 - C. above the phloem
 - D. around the phloem
 - E. in separate bundles from the phloem.
12. A group of similar cells performing the same function is
 - A. an organ
 - B. a system
 - C. a tissue
 - D. an organelle
 - E. an enzyme.
13. Which of the following is common to a dicotyledonous stem and a monocotyledonous root?
 - A. Medullary rays
 - B. Central pith
 - C. Wide cortex
 - D. Narrow cortex
 - E. Pericyclic fibres.
14. Which of the following represents the sequence of protein hydrolysis? 1.Polypeptides 2.Amino acids 3. Proteins 4. Peptones
 - A. 3-1-2-4
 - B. 3-2-4-1
 - C. 3-4-2-1
 - D. 3-4-1-2
 - E. 3-1-4-2
15. A food substance which produces red colouration with Sudan III contains
 - A. protein
 - B. sugar
 - C. starch
 - D. cellulose
 - E. fat.
16. If calcium is deficient in food this may cause
 - A. anaemia
 - B. retarded growth
 - C. sterility
 - D. goitre
 - E. beri-beri
17. Partially digested food ready to leave the stomach is referred to as
 - A. chyme
 - B. curd
 - C. glycogen
 - D. paste
 - E. roughage
18. The function of lymph nodes is to
 - A. supply oxygen
 - B. filter out bacteria
 - C. form red blood
 - D. supply amino acids
 - E. supply simple sugars
19. The vein which returns blood from the head and arms to the heart is called
 - A. aorta
 - B. inferior vena cava
 - C. superior vena cava
 - D. pulmonary vein
 - E. pulmonary artery.
20. Blood platelets are important because they
 - A. are amoeboid and nucleated
 - B. produce antitoxins
 - C. produce antibodies
 - D. digest harmful bacteria
 - E. release thrombin for blood clotting.
21. If a child can receive blood from all donors, he belongs to the blood group
 - A. O
 - B. A
 - C. B
 - D. AB
 - E. AS.
22. Which of the following events does NOT occur during anaerobic respiration of glucose?
 - A. Muscle cells produce lactic acid
 - B. Carbon dioxide is produced
 - C. Milk bacteria produce lactic acid
 - D. Energy is not produced
 - E. Germinating seeds produce alcohol.

23. Identify which of the following are characteristics of the vertebrate respiratory surface
 1. Moist 2. Vascularized 3. Semipermeable 4. Freely permeable 5. Dry
 A. 1,2,3 B. 1,2,5 C. 2,3,5 D. 2,4,5 E. 1,3,5.
24. In mammals, the function of the sebaceous gland is to
 A. produce sweat B. secrete sodium
 C. secrete water D. produce an oily substance
 E. manufacture vitamin D for the skin.
25. Which of the following organs regulates the amount of amino acids and glucose in the body?
 A. Kidney B. Liver C. Pancreas D. Spleen
 E. Stomach.

Use the diagram below to answer questions 26 and 27

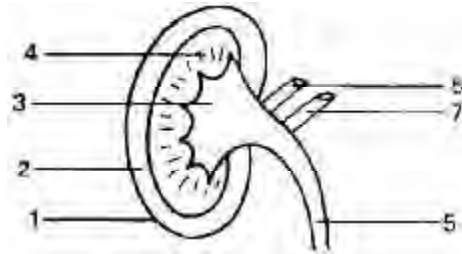

Fig. 1

26. Bowman's capsules are located in the part labelled
 A. 1 B. 2 C. 3 D. 4 E. 5 F. 6
27. Re-absorption of useful materials takes place in the parts labeled.
 A. 1 and 3 B. 3 and 5 C. 5 and 6
 D. 6 and 7 E. 2 and 4
28. Movements and positions of the head in man are detected by the
 A. cochlea B. malleus C. utriculus
 D. semicircular canals E. outer
29. The appendicular skeleton is made up of the
 A. limbs B. skull and limbs C. phalanges
 D. ulna and radius E. girdles and limbs.
30. The maize grain is a fruit and not a seed because it
 A. has a large endosperm B. is formed from an ovary
 C. is a monocotyledon D. has no plumule and radicle
 E. has a hypogeal germination.
31. If a flower is protandrous then it
 A. must be unisexual B. has an undeveloped anroecium
 C. has no anroecium D. must be insect pollinated
 E. can prevent self-pollination.
32. For pollen to be released in *Crotalaria* the insect must depress the
 A. wing B. keel C. standard D. antepetalous stamen
 E. antesepalous stamen.
33. Irish potato is a
 A. bulb B. taproot C. rhizome D. root tuber
 E. stem tuber.

34. The characters by which an organism is recognized are termed its
 A. phenotype B. genotype
 C. morphology D. anatomy E. physiology.
35. The hereditary material in a cell is known as
 A. ADP B. CNS C. RNA D. ATP E. DNA.
36. A young plant showing yellow leaves is likely to be deficient in
 A. calcium B. magnesium C. potassium
 D. boron E. molybdenum.
37. Germination which results in the cotyledons being brought above ground is called
 A. hypocotyls B. epicotyl C. epigeal
 D. hypogeal E. plumule.
38. The mammalian endocrine system is responsible for
 A. transmitting impulses B. regulating body temperature
 C. regulating osmotic pressure of blood
 D. chemical co-ordination E. the manufacture of blood.
39. An old man is likely to be long-sighted because age effects the
 A. optic nerves B. retina C. ciliary muscles
 D. cornea E. aqueous humour.
40. In a mammal, stimulus is transferred from the receptor muscle to the central nervous system through the
 A. motor neurons B. effector muscles
 C. dendrites D. sensory neurons E. synapses.
41. A relationship between living organisms which is of mutual benefit is
 A. parasitism B. saprophytism C. ecosystem
 D. symbiosis E. commensalisms.
42. Which of the following food chains is in the correct sequence?
 A. Weeds → Tadpoles → Beetles → Fish → Man
 B. Weeds → Tadpoles → Fish → Beetles → Man.
 C. Tadpoles → Beetles → Weeds → Man → Fish
 D. Man → Fish → Beetles → Tadpoles → Weeds
 E. Fish → Beetles → Tadpoles → Weeds → Tadpoles.
43. The primary and secondary hosts respectively of bilharzia are
 A. fish and man B. man and dog C. snail and man
 D. man and snail E. fish and snail
44. Which of the following is NOT caused by bacteria?
 A. Cholera B. Gonorrhoea C. Tuberculosis
 D. Onchocerciasis E. Typhoid.
45. Tsetse fly is harmful to man because it is associated with the spread of
 A. river blindness B. malaria C. sleeping sickness
 D. leprosy E. dysentery.

46. Soil erosion *CANNOT* be controlled by
 A. planting cover crops B. contouring of sloping ground
 C. terracing of slopes
 D. laying of mulch E. burning of bush
47. Water retention is highest in soils which are rich in
 A. sand, poor in humus and devoid of clay
 B. clay and sand, but poor in humus
 C. clay and humus, but poor in sand
 D. clay, poor in humus and devoid of sand
 E. Sand and humus, but poor in clay
48. The origin of mineral particles in the soil is
 A. humus B. water C. micro-organisms
 D. weathered rock E. organic matter
49. Atmospheric nitrogen is directly replenished in nature through
 A. the activities of denitrifying bacteria
 B. the breakdown of ammonium salts in the soil
 C. the activities of nitrifying bacteria
 D. the activities of nitrogen-fixing bacteria in root nodules
 E. egestion, death and decay
50. The initial volume of water poured into a bag of dry soil was 50ml and the amount that drained through was 35ml. The percentage water content of the fully soaked soil is therefore
 A. 46.7 B. 25.0 C. 20.0 D. 30.0 E. 58.3.

Biology 1986

1. Viruses are regarded as non-living because they
 A. can neither reproduce asexually nor sexually
 B. cannot survive in their respective environments
 C. do not possess characteristics to the next
 D. can neither respire nor excrete.
2. Which of the following pairs are fully adapted to terrestrial life?
 A. Ferns and algae B. Ferns and mosses
 C. Bryophyte and flowering plants.
 D. Flowering plants and conifers.
3. Which of these animals is radically symmetrical?
 A. Squid B. Hydra C. Snail D. Cockroach.
4. Which of the following has cones?
 A. Angiosperm B. Gymnosperm C. Pteridophyte
 D. Bryophyte .
5. For effective functioning of a bird's quill feather, hooks fit on the ridges of the
 A. vane B. rachis C. barbules D. barbs.
6. Which of the following is NOT true of Spirogyra?
 A. Reproduces by conjugation B. Reproduces by fragmentation
 C. Consists of branched filaments
 D. Consists of unbranched filaments
7. Which of the following lacks chaetae, tentacles and antennae?
 A. Snail B. Crab C. Millipede D. Earthworm.
8. Incomplete metamorphosis in the
 A. butterfly B. grasshopper C. mosquito
 D. housefly
9. Fishes are cold-blooded because their body temperature is
 A. constantly low B. constantly high
 C. dependent on that of their surroundings
 D. regulated at will
10. When the original king and queen of termites die, they are replaced by
 A. the king and queen of another colony
 B. some adult reproductives from the same colony
 C. some adult workers which are specially fed to breed.
 D. Developing nymphs nurtured as secondary reproductives.
11. The male cockroach differs from the female by having
 A. mandibles B. a pair of styles C. spiracles
 D. a pair of cerci.
12. The fins making up the limbs of the bony fish are
 A. caudal and ventral B. ventral and pelvic
 C. pelvic and pectoral D. pectoral and dorsal.
13. The stem differs from the root in having the xylem and phloem strands
 A. on the same radii B. scattered C. on alternate radii
 D. towards the pith.
14. Oxygen liberated during photosynthesis has been demonstrated to come from
 A. carbon dioxide B. air C. water D. chlorophyll.
15. Which of these is a trace element?
 A. Iron B. Copper C. Calcium D. Sulphur.
16. The main organic substances found in the human body are
 A. carbohydrates, proteins and salts B. salts, fats and proteins
 C. fats, carbohydrates and proteins D. salts, fats and carbohydrates.
17. Which of the following elements is essential for the formation of haemoglobin?
 A. Sodium B. Potassium C. Calcium D. Iron.
18. The severe deficiency of vitamin C leads to
 A. kwashiorkor B. beriberi C. pellagra D. scurvy

19. In addition to the high calories derived from fats and oils, they are
 A. used in producing new cells B. necessary for enzyme formation C. used as insulators from cold
 D. required for growth
20. The extract from a food substance reacting with sodium hydroxide and copper sulphate solutions will produce violet to purple coloration if
 A. fats are present B. carbohydrate is present
 C. protein is present D. reducing sugar is present.
21. The three important organs that are situated close to the stomach are
 A. kidney, liver and gall bladder B. pancreas, liver and kidney C. liver, kidney and spleen D. gall bladder, pancreas and spleen.
22. Evidence that a tooth is a living part of the mammalian body can be found within the
 A. gum B. pulp cavity C. cement D. enamel.
23. Blood circulation in a mammal is said to be double because
 A. it passes twice through the heart in the complete circuit B. it moves in both arteries and veins
 C. it circulates in both the heart and other organs
 D. the heart contains auricles and ventricles
24. Which is the correct order of water loss from the leaf? 1 Mesophyll 2 Veins 3 Substomatal cavity 4 Stomata
 A. 3 → 2 → 1 → 4 B. 2 → 3 → 1 → 4
 C. 2 → 1 → 3 → 4 D. 1 → 2 → 3 → 4.
25. The aperture between the left auricle and the left ventricle is guarded by the
 A. auricular valve B. tricuspid valve
 C. ventricular valve D. bicuspid valve.
26. A major limitation in the use of the potometer for measuring the rate of transpiration is that
 A. it is made of breakable glass material
 B. it measures the rate of water intake
 C. it measures the rate of water loss through the stem only D. the movement of the air bubble in the potometer cannot be timed accurately.
27. Which of the following statements is not correct with respect to inhalation in mammals?
 A. intercostal muscles contract B. diaphragm is raised
 C. ribs are raised D. pressure of the thoracic cavity decreases.
28. The equation that can be used to summarize the process of anaerobic breakdown of sugar is
 A. $C_6H_{12}O_6 + 2C_2H_5OH + 2CO_2$
 B. $6CO_2 + 6H_2O \rightarrow C_6H_{12}O_6 + 6O_2$
 C. $C_6H_{12}O_6 + 6O_2 \rightarrow 6CO_2 + 6H_2O + \text{energy}$
 D. $C_6H_{12}O_6 \rightarrow 2C_2H_5OH + 2CO_2 + \text{energy}$.
29. If a person is bitten by a snake on the leg, it is advisable for the person

- A. keep moving so that the venom will ooze out with bleeding B. wash the wound with water containing antiseptic C. bandage the wound so that germs do not get in through it D. keep still and apply a tourniquet above the wound.
30. Deamination occurs in the
 A. kidney B. pancreas C. spleen D. liver.
31. In the mammalian skin, melanin and keratin are contained in the
 A. sebaceous gland B. sweat gland
 C. subcutaneous layer D. malpighian layer.
32. Two main distinguishing features of the cervical vertebra are the presence of
 A. short neural spine and vertebrarterial canal
 B. prezygapophysis and cervical ribs
 C. large centrum and cervical ribs
 D. vertebrarterial canal and large centrum
33. Nastic movement is
 A. response to light stimulus B. non-directional
 C. directional D. response to internal stimulus

Use the figure below to answer questions 34 to 36

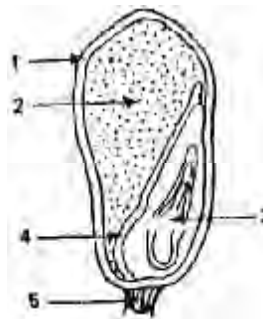

Vertical section of a maize grain

34. Which of the labelled parts will develop into a new maize plant?
 A. 2 B. 3 C. 4 D. 5.
35. The structure labelled 1 is the
 A. plumule B. radicle C. cell membrane
 D. seed coat
36. The main function of the structure labelled 2 is to
 A. protect the inner parts of the seed
 B. nourish the embryo and the growing parts
 C. keep the inner parts moist
 D. maintain the shape of the seed.
37. Gestation in mammals is the period
 A. required for growth after birth
 B. between the formation of the foetus and birth
 C. of development from zygote to birth
 D. before the formation of the zygote.
38. If a woman who is a carrier of sickle cell trait (AS) married a man who is a sickler (SS) and they had four children how many of them would be normal
 A. Three B. Two C. One D. None

39. Which of the following is an example of discontinuous variation?
 A. Skin coloration B. Left-handedness
 C. Body weight D. Height
40. The hormone which regulates the amount of glucose in the blood is called
 A. adrenalin B. auxin C. insulin
 D. thyroxine.
41. An instrument that can be used to demonstrate phototropism and geotropism in plants is the
 A. auxanometer B. potometer C. klinostat
 D. photometer.
42. In an ecosystem, animals which feed directly on plants are called
 A. secondary consumers B. primary consumers
 C. producers D. predators
43. In an agricultural ecosystem, the biotic component consists of
 A. crops, pest and beneficial insects B. crops, temperature and humidity
 C. pests, beneficial insects and water D. crops, water and soil.
44. Which of these diseases CANNOT be prevented by immunization?
 A. Poliomyelitis. B. Tuberculosis
 C. Cholera D. Onchocerciasis
45. Which of the following ecological factors are common to both terrestrial and aquatic habitats?
 A. Rainfall, temperature, light and wind
 B. Salinity, rainfall temperature and light
 C. Tides, wind, rainfall and altitude
 D. Ph, salinity, rainfall and humidity
46. In a community, bacteria and fungi are referred to as
 A. producers B. decomposers C. scavengers
 D. consumers
47. The swollen shoot disease of cocoa tree is caused by a
 A. virus B. fungus C. bacterium D. protozoan
48. A large percentage of tropical soils tend to be acidic because they
 A. contain large quantities of potash B. contain large quantities of lime
 C. lose a high proportion of their organic matter to running water
 D. lose lime and potash from the top soil through rain action
49. The following are methods of soil conservation *EXCEPT*
 A. contour terracing B. strip cropping
 C. contour ploughing D. mixed grazing
50. Samples of different soil types are packed in glass tubes whose lower ends are plugged with cotton wool. If these tubes are suspended in a trough of water, water will rise highest after a few hours in
 A. sand B. loam C. clay D. humus.

Biology 1987

1. The function of endoplasmic reticulum is
 A. protein synthesis B. intracellular transport of materials
 C. digestion and destruction of foreign bodies
 D. production of energy from glucose.
2. Which of the following features of Euglena is found only in animals?
 A. Paramylum granules. B. Flagellum C. Pellicle
 D. Pyrenoid.
3. An organism found on a bare rock surface has features of algae and fungi. The organism is
 A. an empiphyte B. a lichen C. a bryophyte D. a fern.
4. In a plant exhibiting alternation of generations, the diploid multicellular stage is known as
 A. gametophyte B. spermatophyte C. holophyte
 D. sporophyte.
5. A characteristic that distinguishes bryophytes from flowering plants is the
 A. possession of true stems and leaves B. ability to reproduce asexually
 C. absence of vascular tissues D. ability to grow in moist habitats.
6. A good example of a diploblastic organism is
 A. Amoeba B. Hydra C. Earthworm D. Roundworm.
7. The function of the clitellum in the earthworm is to
 A. aid digestion B. prevent desiccation C. assist locomotion
 D. secrete cocoon.
8. The crayfish is an arthropod because
 A. its body consists of a cephalothorax and an abdomen
 B. it has a pair each of antennae and antennules
 C. every segment of its body carries a pair of appendages
 D. its body is covered with an exoskeleton made of chitin.
9. The hypha of Rhizopus is said to be coenocytic because it
 A. does not contain chlorophyll B. has no cross walls
 C. is vacuolated D. stores oil globules.
10. In most true ferns sporangia are grouped into
 A. indusium B. fonds C. prothalli D. sari.

11. In the reproduction of mosses, water is essential because
 - A. they live in moist habitats
 - B. they cannot reproduce without water
 - C. the male gametes must swim to fertilize the ovum
 - D. they produce spores.
12. In tapeworm, the two structures that run through the length of the body are the
 - A. nerve cord and the excretory duct
 - B. sperm duct and the nerve cord
 - C. genital pore and the excretory duct
 - D. sperm duct and the genital pore.
13. Which of the following is NOT a characteristic of snails?
 - A. Bilateral symmetry
 - B. Chitinous exoskeleton
 - C. Muscular foot
 - D. Soft unsegmented body in a mantle.
14. In the life history of a butterfly, destruction of crops is caused by the
 - A. maggot
 - B. nymph
 - C. caterpillar
 - D. pupa.
15. The correct sequence of tissues in the anatomy of a young dicotyledonous stem from the inside to the outside is
 - A. pith, phloem, cambium, xylem, parenchyma, collenchyma and epidermis
 - B. xylem, phloem, cambium, cortex, endodermis, collenchyma and epidermis
 - C. pith, xylem, cambium, phloem, collenchyma, parenchyma and epidermis
 - D. phloem, xylem, cambium, cortex, endodermis, collenchyma and epidermis.
16. Secondary thickening is initiated in a dicotyledonous stem by the
 - A. xylem parenchyma
 - B. secondary phloem
 - C. endodermis
 - D. cambium.
17. In demonstrating the importance of mineral elements in the plants, the culture bottle must be darkened to
 - A. prevent algal growth in culture solution
 - B. allow root growth
 - C. prevent breakdown of mineral elements
 - D. prevent photosynthesis in the root.
18. The vitamin which is important in the formation of the retina pigments is
 - A. vitamin A
 - B. vitamin B
 - C. vitamin C
 - D. vitamin D.
19. Which of the following lists of organs is directly involved in nutrition?
 - A. Oesophagus, bronchus, stomach, pancreas and anus
 - B. Spleen, pharynx, duodenum, jejunum and rectum,
 - C. Teeth, oesophagus, ileum lungs and large intestine,
 - D. Salivary gland, liver, stomach, villi and colon.
20. In the standard experiment to show that oxygen is given off during photosynthesis, sodium bicarbonate is used to
 - A. neutralize the acid in water
 - B. supply mineral salts to water plant,
 - C. supply carbon dioxide for photosynthesis
 - D. Kill micro-organism in water.

21. One cubic centimeter of lymph is richer than an equal volume of blood
 - A. erythrocytes
 - B. leucocytes
 - C. amino acid
 - D. glucose.
22. The oxidative part of the respiration process takes place in the
 - A. mitochondria
 - B. ribosomes
 - C. endoplasmic reticulum
 - D. golgilbodies.
23. Fatigue of leg muscles may occur after riding many kilometers on a bicycle because of
 - A. insufficient glucose
 - B. excess carbon dioxide
 - C. excess protein
 - D. insufficient oxygen.
24. The function of the loop of Henle is to
 - A. increase the flow of urine
 - B. concentrate amino acids in the kidney tissue
 - C. concentrates sodium chloride in the medulla of the kidney
 - D. increase the volume of urine.

Use the information in the graph below to answer question 25 and 26

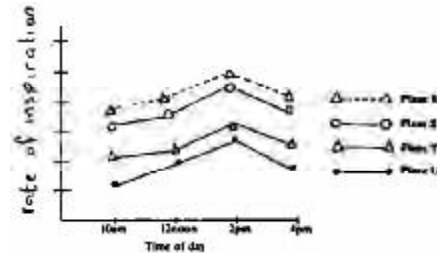

25. Which of the plants is likely to have broad leaves with thin cuticle?
 - A. R.
 - B. S
 - C. T
 - D. U
26. Which of the plants is likely to be a desert species?
 - A. U
 - B. T
 - C. S
 - D. R.
27. Sclerenchyma cells are lignified to
 - A. strengthen and support the plant
 - B. transport synthesized food
 - C. conduct water and salt
 - D. protect the plant from injury.
28. The pineapple fruit is best described as
 - A. aggregate, succulent and indehiscent
 - B. aggregate, succulent and indehiscent
 - C. multiple, succulent and indehiscent
 - D. multiple, succulent and dehiscent.



29. The flower shown above is
 - A. complete, regular, hermaphroditic with inferior ovary
 - B. incomplete, regular, staminate with inferior ovary
 - C. complete regular, hermaphroditic with inferior ovary
 - D. incomplete, irregular, pistillate with superior ovary.

30. A flower showing radial symmetry is said to be
A. pentamerous B. protandrous C. protogynous
D. actinomorphic.
31. A samara differs from a cypsela by having
A. an extended pericarp B. a hard pericarp
C. a pericarp fused with the seed coat
D. some hairy outgrowths on the pericarp.
32. The plantain reproduces asexually by
A. suckers B. buds C. fragments D. spores.
33. Growth can best be determined in a population of Spirogyra by measuring the
A. total lengths of the filaments B. total widths of the filaments
C. rate of photosynthesis in the population D. dry weight of the organism.
34. Most cells in higher animals retain their power of division EXCEPT
A. lymphocytes B. nerve cells C. malpighian cells
D. germ cells.
35. A severe deficiency of thyroxin results in
A. diabetes mellitus B. sexual underdevelopment
C. cretinism D. gigantism.
36. The growth of a coleoptile towards unilateral light source is due to
A. rapid rate of photosynthesis B. unequal distribution of auxin
C. the effect of geotropism
D. the effect of photolysis.
37. The sequence of ear ossicles from the fenestra ovalis is
A. malleus, incus and stapes B. malleus, stapes and incus
C. stapes, incus and malleus D. stapes, malleus and incus.
38. The centre for controlling body temperature in the brain is the
A. cerebrum B. cerebellum C. medulla
D. hypothalamus.
39. Unlike auxins, gibberellins
A. induce the formation of adventitious roots
B. do not affect leaf and fruit abscission
C. cannot stimulate stem elongation
D. are quite effective as herbicides.
40. A gene which expresses itself only in the homozygous condition is
A. a mutant B. dominant C. recessive D. lethal.
41. An example of monohybrid inheritance in man is
A. astigmatism B. cretinism C. hyperthyroidism
D. albinism.
42. If a plant, homozygous for round and yellow (RR;YY), is crossed with a wrinkled green type (rr;yy) all of the resulting seed will be
A. blue and wrinkled B. round and yellow
C. wrinkled and yellow D. round and greenish-yellow.
43. The ratio of carriers to sicklers in the F_1 generation derived from a parental cross of two carriers of haemoglobin S gene is
A.3:1 B. 1:3 C.2:1 D. 1:2
44. In which of the following crosses will all the female offspring be colour blind?
A. colour blind mother x colour blind father.
B. colour blind mother x normal father
C. carrier mother x colour blind father.
D. carrier mother x normal father.
45. Which of the following relates to edaphic factors?
A. The structure of the earth's surface B. The influence of living organisms on each other.
C. Temperature, rainfall and humidity
D. The influence of soils on plants and animals.
46. Epiphytes growing on the branches of trees provide an example of the relationship known as
A. parasitism B. commensalism C. aphytism
D. holophytism.
47. Poliomyelitis is an infectious disease caused by
A. virus B. protozoan C. bacterium D. fungus.
48. One of the functions of UNICEF is to
A. prevent and control major diseases B. prevent disease outbreak by administering vaccines
C. improve the health and nutrition of children and nursing mothers
D. monitor environment pollution.
49. Nitrifying bacteria are important because they
A. release nitrogen to the atmosphere B. convert Atmosphere nitrogen to ammonia
C. combine ammonia with nitrogen
D. oxidize ammonium salts to nitrates.
50. The process by which lime is added to clay soils is known as
A. sedimentation B. flocculation C. leaching
D. manuring

Biology 1988

- The function of ribosomes in cells is
A. protein synthesis B. starch synthesis
C. transport of materials D. lipid storage.
- Which of the following structures is common to Euglena, white blood cell and Amoeba?
A. Vacuole B. Cell wall C. Cilia D. Cell membrane.
- The term 'Thallophyta' refers to
A. ferns and mosses B. algae and fungi C. mosses and liverworts D. fungi and ferns.
- The following organisms are hermaphrodites EXCEPT
A. snail B. taenia C. schistosoma D. earthworm.
- Parasitic forms are NOT found among
A. platyhelminthes B. nematodes C. moluscs
D. annelids.
- Which of the following sets of organism represents the correct trend from simple to complex structural organization? 1 Mollusca 2 Platyhelminthes 3 Nematoda 4 Protozoa
A. 4 → 1 → 2 → 3 B. 4 → 3 → 2 → 1
C. 4 → 2 → 1 → 3 D. 4 → 2 → 3 → 1.
- Spirogyra, Euglena and Chlamydomonas share many characteristics EXCEPT
A. nutrition B. reproduction C. mobility
D. irritability.
- The prothallus of a fern is equivalent to the gametophyte generation of a moss because it
A. is inconspicuous B. has rhizoids C. bears sexual organs D. is multicellular.
- What is the function of trichocyst in Paramecium?
A. Movement B. Defence C. Excretion D. Reproduction.
- Which stage is found in the muscle of an infected pig?
A. 3 B. 4 C. 5 D. 6
- The long and coiled intestine of a young tadpole is an adaptation to its
A. herbivorous diet B. carnivorous diet C. aquatic habitat D. insectivorous habit.
- Lung hooks are used for respiration in
A. spiders B. insects C. millipedes D. snails.
- Insects and millipede have many features in common EXCEPT
A. exoskeleton B. jointed, appendages
C. Compound eyes D. segmented body
- The major function of the swim-bladder in fishes is
A. breathing B. buoyancy C. swimming D. diving
- Which of the following statement gives the BEST description of bark?
A. Tissues outside the vascular cambium
B. Cork-like tissues found only in stems C. Brown tissues never found in primary growth
D. Cork-like tissues of old trees.
- In the transverse section of the leaf of maize vascular bundles are arranged in
A. a row B. one circle C. alternate positions D. two circles.
- If an animal has diastema, it would NOT possess
A. incisors B. canines C. premolars D. molars
- If the gall bladder of a mammal is damaged, which of the following will be most seriously affected?
A. Glycolysis B. Digestion of starch C. Digestion of fats and oils D. Digestion of proteins.

Use the diagram below to answer questions 10 and 11

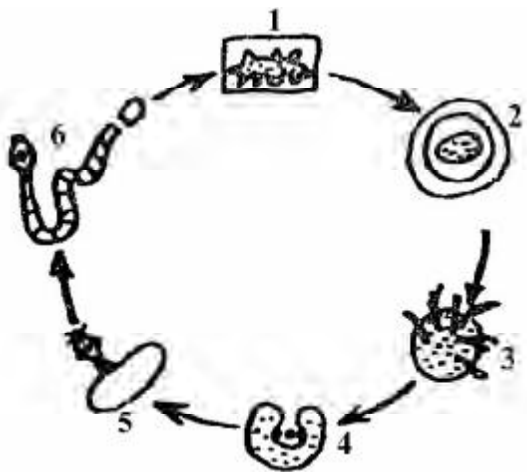

- At which stage in this cycle can man be infected?
A. 2 B. 4 C. 5 D. 6.
- Which of the following will be first digested if ingested at the same time?
A. Cooked beans B. Cooked rice C. Cod liver oil
D. Roasted beef.
- If the phloem of a healthy plant is killed by heat treatment the
A. upward movement of salts will cease B. food manufacture in the leaves will accumulate C. whole plant will die immediately D. leaves of the plant will become yellow.
- In the mammalian respiratory system, exchange of gases occurs in the
A. lungs B. bronchi C. bronchioles D. alveoli.
- The main waste products formed in plant are
A. alkaloids, tannins and resins B. water, alkaloids and carbon dioxide
C. water, carbon dioxide and oxygen.

24. In the kidney the malpighian corpuscle is located in the
A. medulla B. helium C. cortex D. pelvis.
25. The skin, through the sweat glands, functions as
A. an excretory organ B. a respiratory organ C. a sensory organ D. a protective organ.
26. Parenchyma cells serve as supporting tissue when they
A. contain chloroplasts B. have crystals C. become flaccid D. become turgid.
27. Taxism differs from tropism because
A. the whole organism is affected B. it is a directional movement C. it is a response to multi-directional stimuli D. part of the organism is affected.
28. A dry dehiscent fruit which breaks up into one seeded parts is a
A. schizocarp B. capsule C. follicle D. legume.
29. Airspaces are characteristic of seeds or fruits dispersed
A. birds B. water C. wind D. explosive mechanism.
30. In vegetative propagation, which of the following requires part of another plant to develop?
A. Scion B. Bulb C. Rhizome D. Sucker
31. Which of these plant groups are normally propagated by asexual means?
A. Banana, yam, pineapple and cassava B. Yam, cassava, rubber and banana C. Yam, cassava, orange and banana, D. Banana, cassava, coffee and pineapple.
32. In a mammal, the placenta performs functions similar to those of the
A. lungs, kidneys and digestive system B. lungs, heart and nervous system C. liver, intestines and reproductive system D. intestines, heart and digestive system.
33. The radicle of a bean seedling grows most rapidly in the region
A. of the root tip B. just above the root tip C. just around the root tip D. just below the root tip.
34. The main function of the choroid is
A. protection of the eye ball B. transmission of light C. supply of nutrients to tissues of the eye D. converging light.
35. What part of the central nervous system is concerned with answering an examination question?
A. Cerebrum B. Cerebellum C. Medulla oblongata D. Spinal cord.
36. If a dark-skinned woman (Bb) marries an albino man (bb) and they have four children, how many of the children will be dark-skinned?
A. 3 B. 2 C. 1 D. 0.
37. A red - coloured flower when crossed with a white-coloured one produced pink flowers. This is an example of
A. complete dominance B. blending inheritance C. interaction of genes D. back crossing.
38. The turbidity of a pond can be measured using the
A. anaemometer B. secchi disc C. theodolite D. hydrometer.
39. The most important substances necessary for the maintenance of life are carbon, oxygen
A. hydrogen, soil and enzymes B. hydrogen, salt and water C. nitrogen, salt and soil D. nitrogen, salt and water.
40. If an organism obtains its food by means of haustoria, it is said to be
A. holophytic B. heterophytic C. Saprophytic D. Parasitic.
41. Which of the following relationship involves only one organism?
A. Saprophytism B. Commensalism C. Parasitism D. Symbiosis.
42. Which of the following has the greatest influence on the distribution of animals in marine and fresh water habitats?
A. pH B. Salinity C. Water current D. Turbidity
43. Which of these groups of animals is likely to be found in fresh water?
A. Blood worm, pond skater and scorpion B. Blood worm, pond skater and dragonfly larva C. Pond skates scorpion and dragonfly larva. D. Pond skater, blood worm and ant-lion.
44. One of the characteristics of plant in the savanna is the
A. possession of thin, smooth barks B. possession of large tap roots C. production of seedlings on mother plant D. possession of thick, flaky barks.
45. Which of the following disease can be contracted areas with fast flowing rivers?
A. Schistosomiasis B. Elephantiasis C. Syphilis D. Onchocerciasis.
46. Which of the following causes pollution?
A. Consumption of canned drinks. B. The addition of fertilizer to farmland C. Respiration of living organisms D. Burning of refuse.
47. The mineral nutrient that is most bound to the soil is
A. phosphorus B. calcium C. iron D. potassium.
48. The mineral nutrient that easily gets leached out of the soil is
A. phosphorus B. calcium C. magnesium D. nitrate.

49. Most commercial fertilizers are rich in salts of
 A. Sodium, iron and calcium B. nitrogen, phosphorus and potassium C. iron, copper and nitrogen D. calcium, sodium and phosphorus.
50. Dead plants and animals are decomposed by bacteria and fungi into
 A. butterfly B. grasshopper C. mosquito D. housefly.

Biology 1989

Use the figure below to answer questions 1 to 3

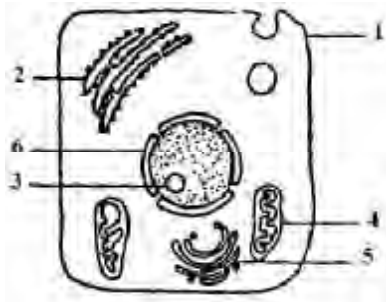

- The structure labelled 5 is the
 A. nucleolus B. Golgi body C. mitochondrion D. vacuole
- Which of the labelled parts of the cell contains ribonucleic acid?
 A. 1 B. 2 C. 3 D. 5
- Which structure is known as the power house of the cell?
 A. 6 B. 5 C. 4 D. 3
- When a virus is placed in a non-living medium it
 A. becomes dehydrated B. forms spores
 C. forms flagella D. becomes crystallized.
- A characteristic of the phylum coelenterate is that
 A. most of them are marine B. they possess a gut with a single opening
 C. they possess numerous pores on their body D. they are bilaterally symmetrical.
- A multinucleate body without internal cell boundaries is characteristic of
 A. bryophytes B. fungi C. algae D. gymnosperms.
- Double fertilization is a unique feature of
 A. angiosperms B. bryophytes C. pteridophytes D. algae.
- Which of the following phyla have members with both internal and external segmentation?
 A. Platyhelminthes B. Nematoda C. Algae D. Mollusca
- Mineral salts can be absorbed into the roots by
 A. osmosis only B. osmosis and diffusion
 C. diffusion and active transport D. imbibition only.

- Which of the following is a common characteristic of crustaceans?
 A. Possession of a pair of antennae
 B. Possession of two pairs of antennae.
 C. Each segment has a pair of walking legs
 D. Four pairs of walking legs on the cephalothorax.
- The pedipalpi in spiders are used for
 A. grasping B. Walking C. feeling D. Web spinning.
- The body of a snail is divided into head
 A. thorax and abdomen B. visceral mass and abdomen
 C. thorax and foot D. visceral mass and foot.

Use the diagram below to answer questions 13 to 14

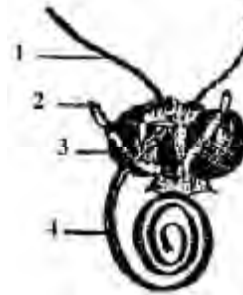

- Which of the labelled parts is used for feeling?
 A.1 B.2 C.3 D.4
- The structure labelled 2 is the
 A. compound eye B. ocellus C. antenna D. labial palp.
- In a dicotyledonous stem, each companion cells is found beside the
 A. endodermal cell B. xylem vessel
 C. sieve tube D. pericyclic fibre.

Use the diagram below to answer questions 16 to 17

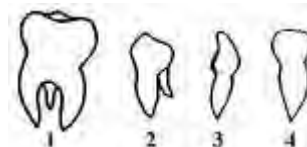

- Which of the structure's is the molar?
 A.1 B.2 C. 3 D.4
- What is the function of 3?
 A. Cutting off large pieces of food.
 B. Seizure and tearing of prey
 C. Grinding of food D. Tearing of flesh only

18. If a healthy potted plant is continuously kept in dim of light
 A. the rate of respiration may equal that of photosynthesis B. more carbon dioxide and water are taken in C. respiration may be halted D. the volume of oxygen released increases.
19. The pancreatic juice contains the enzymes amylopsin,
 A. pepsin and trypsinogen B. rennin and steapsin C. steapsin and trypsinogen D. steapsin and ptyalin.
20. Aged erythrocytes are destroyed in the
 A. pancreas B. liver C. lymph nodes D. kidney.
21. The seedlings in a rice field were found to have thin lanky growth with reddish leaves and poor root development. This is because the soil lacks
 A. sulphur B. phosphorus C. potassium D. iron.
22. There will be agglutination when the
 A. Group A serum mixes with Group A erythrocytes
 B. Group A serum mixes with Group B erythrocytes
 C. Group AB serum mixes with Group O erythrocytes
 D. Group B serum mixes with Group B erythrocytes.

Use the figure below to answer questions 24 to 26

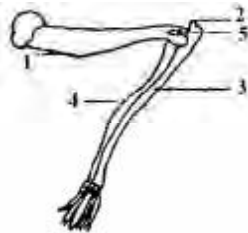

23. Which of the following is the function of lymph?
 A. Carries hormones round the body B. Transport nutrient and oxygen from blood, capillaries to the cells. C. Distributes heat uniformly round the body D. Conveys aminoacids and glucose from the small intestine to the liver.
24. The type of joint at the point labelled 5 is the
 A. pivot joint B. gliding joint C. ball and socket D. hinge joint.
25. Which of the labelled bones is the ulna?
 A. 1 B. 3 C. 4 D. 5
26. What is the name of the structure labelled 2?
 A. Odontoid process B. Olecranon C. Patella D. Condyle.
27. The lumbar vertebra when compared with a thoracic vertebra has a
 A. longer neural spine B. wider neural canal C. thicker centrum D. shorter transverse process.
28. Wind-pollinated flowers usually have
 A. rough pollen grains B. sticky stigmas C. small and short stigmas D. long styles.
29. The components of castor oil seed and the maize grain are similar EXCEPT for the
 A. number of cotyledons B. location of the embryo C. number of radicles D. number of plumules.
30. A corm differs from a bulb in that
 A. its stem is the main food storage organ B. it has a flattened disc-shaped stem C. buds are absent in the axils of the leaves D. adventitious roots are present
31. Exponential increase in the population of an organism is a characteristic feature of
 A. binary fission B. sexual reproduction C. budding D. vegetative propagation.
32. The irreversible life process by which new protoplasm is added to increase the size and weight of an organism can be termed
 A. anabolism B. catabolism C. growth D. development.
33. Fruit enlargement can be induced by spraying young ovary with
 A. cytokinin, abscisic acid and ethylene
 B. gibberellin, ethylene and abscisic acid
 C. auxin, abscisic acid and ethylene
 D. auxin, cytokinin and gibberellin.
34. A fundamental similarity between nervous and hormonal system is that both
 A. involve chemical transmission B. have widespread effects C. shed chemicals into the blood stream D. evoke rapid responses.
35. The region that controls most of the unconscious processes of a mammalian body is the
 A. cerebellum B. cerebrum C. spinal cord D. medulla oblongata.
36. During cell division, the two strands of chromosomes are joined at a point called
 A. spindle B. chromatid C. centromere D. aster.
37. When the two alleles present in an organism are of the same type, the genotype is described as
 A. heterozygous B. heterogamous C. homozygous D. homologous.
38. If parents with blood groups AB and OO produce six children
 A. three of them will have group B
 B. two of them will have group A
 C. all the offspring will have group O
 D. none of them will have group A.
39. Which of the following is a sex-linked character?
 A. Sickle-cell anaemia B. Tongue rolling C. Skin colour D. Colour blindness

40. In an ecosystem, the LEAST efficient energy transfer link is from
 A. producers to primary consumers B. sun to producers C. primary consumers to secondary consumers D secondary consumers to decomposers.
41. Lichen is an example of
 A. a saprophytic organism B. a symbiotic association C. an epiphytic plant D. a carnivorous plants .
42. A physiological adaptation of plants to the problem of excessive water loss is
 A. reduction in the number of stomata
 B. reversal of the normal stomatal rhythm
 C. possession of shallow roots
 D. possession of waxy cuticle.
43. Which of the ways of controlling bilharzia can result in pollution?
 A. Clearing water weeds on which the snails feed.
 B. Treating infected people with drugs
 C. Preventing contamination of water by infected urine and faeces D. Applying chemical to kill the snails.
44. Which of the following diseases can be caused by a bacterium?
 A. ringworm B. poliomyelitis C. malaria D. syphilis.
45. Which of the following is a dangerous product of coal buming?
 A. sulphur dioxide B. carbondioxide C. carbon D. nitrogen.
46. 5g of oven dried soil was heated in a furnace for 24hours, after cooling, it weighed 4.8g what is the amount of humus in the soil?
 A. 40.0g per 100g dry soil B.4.4g per 100g dry soil
 C. 4.0g per 100g dry soil D. 0.4g per 100g dry soil.
47. Most irrigated lands often become unproductive in later years because of
 A. loss of fertility B. increase in salinity C. soil erosion D. loss of water
48. Farmers practices crop rotation because it
 A. helps to prevent soil erosion B. allows two crops to be planted at the same time
 C. helps to conserve soil fertility
 D. is an alternative to shifting cultivation

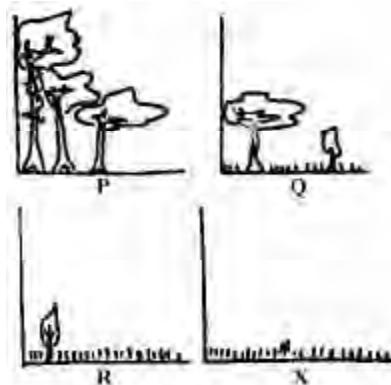

49. In which of the habitant will the plants show xeromorphic features most prominently?
 A.X B.R C.P D.Q
50. Which ecological factor exerts the greatest influence on the structure of the profiles?
 A. topographic B. edaphic C. biotic D. climatic.

Biology 1990

1. Viruses are considered to be living organisms because they
 A. possess transmittable characters B. move from one place to another C. respond to stimulation
 D. ingest food materials
2. Which of the following characteristics is common to *Amoeba* and *Paramecium*?
 A. Oral groove B. Trichoyost C. Contractile vacuole
 D. Cilia
3. *Hydra* removes undigested food by
 A. passing it through the anus B. passing it through the mouth C. means of a contractile vacuole
 D. egesting it through the body surface.
4. Which of the following groups of invertebrates reproduces by budding
 A. Arthropoda B. Annelida C. Mollusca
 D. Coelenterata.
5. The algae, bryophytes and pteridophytes are similar in that they
 A. are sea weeds B. have no vascular tissues
 C. require moisture for fertilization
 D. are microscopic plants.
6. The spores of ferns are dispersed by
 A. wind B. water C. insects D. explosive mechanism.

7. In bryophytes, sex organs are produced in the
 A. gametophyte B. rhizoid C. protonema
 D. sporophyte

Use the figure below to answer questions 8 and 9

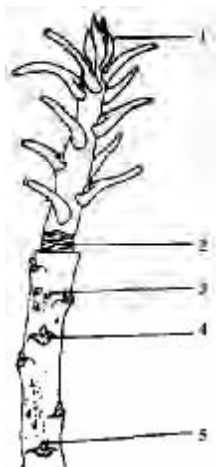

8. The part labelled 3 is the
 A. leaf scar B. lenticel C. auxiliary bud D. girdle scar
9. Which part of the twig produces auxins?
 A.4 B.3 C.2 D.1
10. Which of the following animals has homodont dentition?
 A. Rat B. Man C. Lizard D. Pigeon.
11. In which of the following does external fertilization take place?
 A. Toad B. Lizard C. Bird D. Cockroach.
12. In the tapeworm, the suckers on the scolex are used for
 A. sucking the blood of the host B. holding fast to the host
 C. reproduction D. locomotion
13. A feature which adapts birds to flight is the possession of
 A. scaly legs B. light bones C. two walking legs
 D. a pointed beak.
14. The nephridia in the earthworm form part of the
 A. reproductive system B. respiratory system.
 C. circulatory system D. excretory system.
15. Which of the following diseases is rarely spread by a housefly?
 A. Yellow fever B. Dysentery C. Typhoid fever
 D. Poliomyelitis
16. Which of the following cells is thin-walled and living at maturity?
 A. Collenchyma B. Sieve tube C. Xylem vessel
 D. Sclerenchyma.
17. The mode of nutrition in which digestion is extracellular is
 A. holophytic B. parasitic C. holozoic
 D. saprophytic.

18. The first step in the process of photosynthesis is the
 A. activation of the chlorophyll B. photolysis of water
 C. reduction of carbon dioxide D. formation of sugar.
19. Which of the following food substances will produce a brick-red colour when warmed with Benedict's solution
 A. Glucose B. Starch C. Egg white D. Maltose.
20. The organ which secretes digestive enzymes as well as hormone is the
 A. liver B. salivary gland C. pancreas D. spleen.
21. The villus in the small intestine is significant because it
 A. increases the surface area for absorption
 B. increases the surface area for digestion C. assists in mixing digested food
 D. assists in filtering undigested food.
22. If a ring of bark and phloem is removed from a stem, the
 A. plant dies immediately B. plant dies after two days
 C. movement of food is not affected D. movement of mineral salts is hardly affected.
23. Transpiration can be measured with a
 A. photometer B. hygrometer C. potometer
 D. barometer.
24. Excretory products responsible for the red, purple and blue colours of flowers are called
 A. alkaloids B. tannins C. anthocyanins D. resins.
25. Etiolation is caused by the influence of
 A. mineral salts B. water C. carbon dioxide D. light.
26. Muscles are indirectly attached to bones by means of
 A. ligaments B. membranes C. tendons D. sutures.

Use the figure below to answer questions 27 and 28.

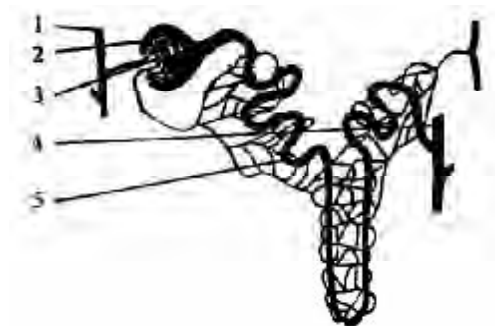

27. Which structure is the glomerulus?
 A. 5 B. 3 C. 2 D. 1.
28. If the blood is too concentrated, more water is absorbed from
 A. 5 B. 4 C. 3 D. 1
29. During mammalian embryo development, large amount of oestrogen and progesterone are produced in the
 A. umbilical cord B. amnion C. placenta D. amniotic fluid.

30.

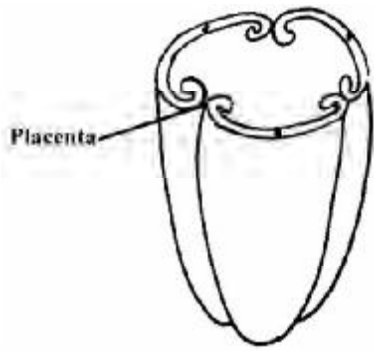

The type of placentation shown in the figure above is
 A. parietal B. marginal C. axile D. free-central.

31. Fruits which develop without fertilization are described as
 A. simple B. parthenocarpic C. aggregate D. compound
32. The elephant grass is propagated vegetatively by means of
 A. corms B. bulbs C. suckers D. solons.

Use the figure below to answer questions 27 and 28.

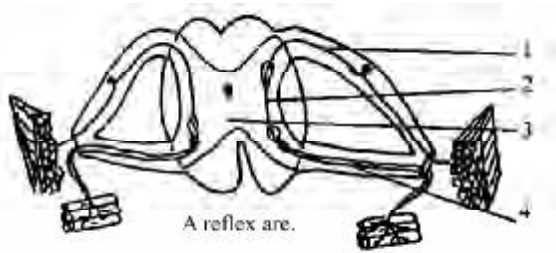

33. All the cell bodies in the spinal cord are found in
 A.1 B.2 C.3 D.4
34. In a reflex action, impulse flows from
 A. 1 to 2 B. 2 to 1 C. 4 to 1 D. 4 to 2
35. The part of the ear that is concerned with balance is the
 A. semi-circular canals B. incus C. malleus D. Bastachian tube.
36. In an organism where the 2nd number of chromosomes is 16, the number of chromosomes in each gamete will be
 A. 32 B. 16 C.8 D. 4
37. What would be the result of the first filial generation (F_1) and the second filial generation (F_2) of a mono-hybrid cross between pure line normal-winged Disophila? flies and pure line short-winged flies of the gene for the normal wing is dominant?
 A. F_1 flies all short-winged and F_2 flies all normal-winged.
 B. F_1 flies all normal-winged and F_2 flies all short-winged.
 C. F_1 flies all short-winged and three-quarters of F_2 flies are short-winged
 D. F_1 flies all normal-winged and three-quarters of F_2 flies are normal-winged.

38.

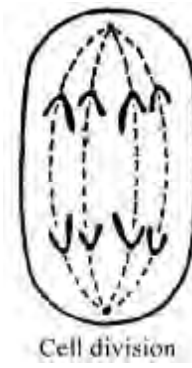

What stage during cell division is represented in the figure above

- A. prophase B. metaphase C. anaphase D. telophase
39. An individual in the AB blood group is a universal recipient for blood conation because
 A. all the red blood cells do not carry antigen
 B. all the red blood cells carry antigen A
 C. all the red blood cell carry antigen B
 D. there are no anti-A and anti-B antibodies in the serum.
40. Haemophilia results from the mutation of the genes
 A. in the sex chromosomes B. which control skin colour
 C. which control the mechanism for blood-clotting
 D. which control the formation of haemoglobin.
41. In a savanna ecosystem, the abiotic factors include
 A. legumes, temperature and sandy soil
 B. water, temperature and soil C. minerals, oxygen and reptile
 D. water, soil and grasses.

Use the figure below to answer questions 42 and 43.

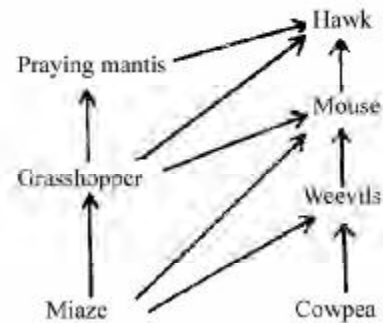

42. Which organism is an omnivore?
 A. Praying mantis B. Hawk C. Mouse D. Grasshopper.
43. Which of the organisms will have the lowest population in an ecosystem?
 A. Hawk. B. Cowpea C. Praying mantis D. Mouse.
44. The salinity of a brackish environment.
 A. increases immediately after rain B. increases at the end of the rainy season
 C. decreases with increase in micro-organisms D. increases during the dry season.
45. Physiological adaptation to very dry condition in animals is called
 A. hibernation B. aestivation C. rejuvenation
 D. xeromorphism

46. Which set of diseases is spread mainly by insect vectors?
 A. cholera, tenia and gonorrhoea. B. poliomyelitis, tuberculosis and sypillis. C. cholera, malaria and tuberculosis D. malaria, cholera and river blindness.
47. Which of the following constitutes pollution?
 A. Droppings from birds B. Loud disco music
 C. A pack of cigarettes D. Refuse in an incinerator.
48. An acidic soil can be improved upon by
 A. Sedimentation B. Leaching C. Flocculation
 D. Watering.
49. What do bacteria in root nodules derive from the host plant?
 A. Protection and minerals B. Water and minerals.
 C. Carbohydrates and water D. Protection and carbohydrates.
50. Free nitrogen is released to the atmosphere by
 A. nitrogen fixing bacteria B. nitrifying bacteria
 C. denitrifying bacteria D. saprophytic bacteria.

Biology 1991

Use the figure below to answer questions 1 and 2.

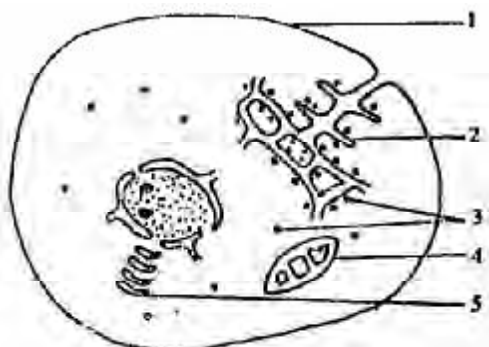

Animal Cell

1. Which of the following structures is associated with aerobic respiration?
 A.1 B.2 C.3 D.4
2. The structure labelled 5 is used for
 A. protein synthesis B. energy production
 C. secretion D. excretion.
3. Angiosperms and gymnosperms belong to the plant group known as
 A. schizophyta B. bryophyta C. pteridopyta
 D. spermatophyta.
4. Which of the following are non-green plants?
 A. Euglena B. Fungi C. Spirogyra D. Angiosperms.
5. Sting cells are normally found in
 A. flatworms B. hydra C. snails D. paramecium.
6. Which of the following are differentiated into true roots, stems and leaves?
 A. Algae B. Schizophyta C. Pteridophyta
 D. Bryophyta
7. To facilitate gaseous exchange, breathing roots have
 A. tomato B. mitochondria C. cuticle D. lenticels.

8. The annulus of fern sporangium helps in
 A. spore dispersal B. conduction of mineral salt
 C. trapping of light energy D. water retention.
9. One of the features which adapts paramecium to its environment is the possession of
 A. a regular shape B. two nuclei C. cilia D. a pellicle.
10. In the earthworm, the cocoon is secreted by the
 A. chaeta B. prostomium C. peristomium
 D. clitellum.
11. The function of maxillipeds in crayfish is to aid
 A. walking B. swimming C. feeding D. respiration.
12. The respiratory organ in the land snail is the
 A. radula B. mantle C. tentacle D. foot.

Use the figure below to answer questions 13 and 14.

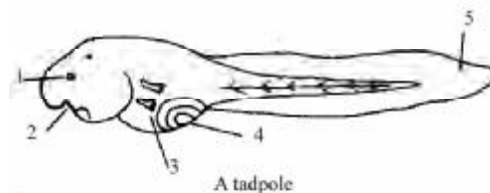

A tadpole

13. The structure labelled 4 is for
 A. feeding B. attachment C. excretion D. respiration.
14. As the tadpoles develops, the structure labelled 5
 A. grows longer B. becomes shorter C. becomes the hind legs D. remains unchanged.
15. The gill rakers of fishes take part in
 A. feeding B. respiration C. swimming D. diffusion.
16. A wide pith with a ring of conducting tissue is characteristic of the root of
 A. sunflower B. maize C. bean D. okra.
17. Which of the following is formed immediately after the first product of photosynthesis?
 A. Lipid B. Starch C. Oxvgen D. Sugar

Use the figure below to answer questions 18 and 19.

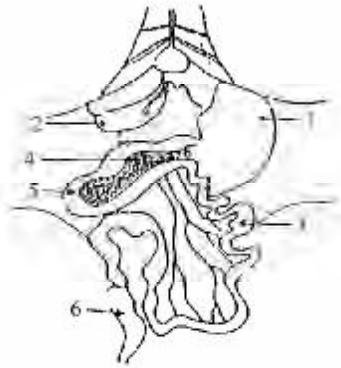

Dissection showing the Abdominal Cavity of a rat

18. In the digestive system, absorption of nutrients into the blood takes places in the part labeled
A.1 B.2 C.3 D.4
19. The gland which produces trypsin, amylase and lipase is labelLed
A. 6 B.4 C.2 D.1
20. One of the accessory organs of the digestive system is the
A. kidney B. spleen C. liver D. lung.
21. The element common to protein, carbohydrate and lipid is
A. hydrogen B. sulphur C. nitrogen D phosphorus.
22. The crown of the mammalian tooth is covered with
A. cement B. dentine C. caries D. enamel.
23. In living cells, insufficient oxygen may cause a breakdown of glucose into
A. fatty acids B. lactic acids C. glycogen
D. carbondioxide.
24. Which of the following can bring about the greatest increase in the rate of transpiration?
A. Increased humidity B. Reduced temperature
C. Reduced wind speed D. Reduced humidity.

Use the figure below to answer questions 25 and 26.

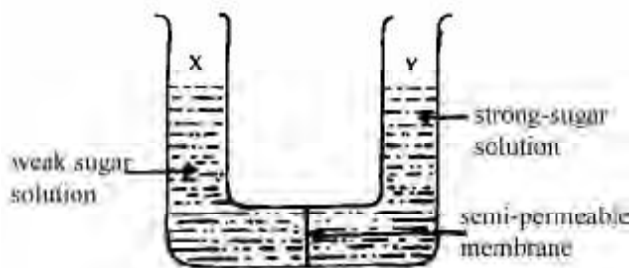

25. After 30 minutes, the level of sugar solution the above figure will
A. rise in X only B. rise in Y only C. be the same in X and Y D. fall in Y.
26. The process by which water moves from X to Y through the semi-permeable membrane is called
A. diffusion B. osmosis C. active diffusion
D. osmoregulation.

27. Fibriongen and prothrombin play important roles in the
A. deamination of proteins B. clotting of blood
C. detoxication of substances D. storage of vitamins.
28. Deoxygenated blood flows into the right and left lungs through the
A. pulmonary vein B. vena cava C. pulmonary artery
D. subclavian vein .
29. Which of the following is a plant excretory product?
A. Oil B. Cytokinin C. Resin D. Amino acids.
30. The movement of the whole organism to an external stimulus is termed
A. tropism B. a taxis C. a nastic movement
D. a phototrophic movement.
31. Which of the following vertebrate lays a centrum?
A. Atlas B. Axis C. Thoracic D. Lumbar
32. The function of the epididymis in mammals is the
A. expulsion of urine B. storage of sperms
C. circulation of blood D. activation of sperms.
33. A collection of achenes formed from several carpels of a flower is
A. a multiple fruit B. an aggregate fruit
C. a schizocarp D. a simple fruit.
34. Vegetative propagation is described as asexual reproduction because
A. reproductive organs are not involved B. new individuals are not formed
C. many new plants are produced D. there is no exchange of genetic materials.
35. Epigeal germination can be found in
A. sorghum B. maize C. millet D. groundnut.
36. A dwarf plant can be stimulated to grow to normal height by the application of
A. thyroxin B. gibberellin C. insulin D. kinin.
37. The greatest contribution to genetic studies was made by
A. Thomas Morgan B. Gregor Mendel
C. Charles Darwin D. Robert Hooke.
38. The exchange of genes between homologous chromosomes is called
A. test cross B. back cross C. crossing –over
D. mutation.
39. When two heterozygotes mate, the dominant trait will appear in
A. the F₁ generation only B. the F₂ generation only
C. both the F₁ and F₂ generations D. neither the F₁ nor F₂ generation.
40. Which of the following characters is NOT sex-linked?
A. River blindness B. Baldness.
C. Haemophilia D. Colour Blindness

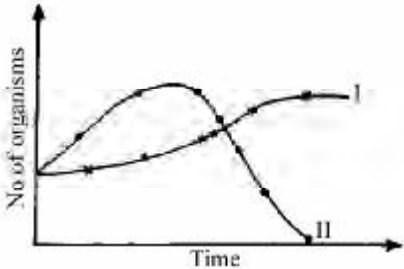
41. The most important factors which influence an organism's way of life in its habitat are
 A. the physical and biotic environment B. food and water availability C. temperature, water, light and predator- prey relationship D. competition for food and space.
42. Organisms in an ecosystem are usually grouped according to their trophic level as
 A. carnivores and epiphytes B. consumers and parasites C. producers and consumers D. producers and saprophytes.
43. 

The above diagram represents a competitive interaction between organisms in communities I and II. Which of the following statement is CORRECT?
 A. The population of I was higher than II at the beginning of the experiment. B. II was wiped out from the environment at the end of the experiment. C. The population of II was always lower than that of I D. The population of I was lower at the end of the experiment than at the beginning.

44. A food web is more stable than a food chain because.
 A. it contains more organisms B. it has greater energy source C. it is not easy to destroy D. every organism has an alternative food source.

45. Which of the following is likely to occur in a deciduous forest during the dry season?
 A. New leaves are formed B. The trees die off. C. The undergrowth increases D. The ground becomes bare.

46. Which of these is NOT an adaptive feature for arboreal life?
 A. Possession of a long tail B. Possession of claws C. Possession of teeth D. Counter shading in coat colour.

47. Which of the following diseases can be prevented by inoculation?
 A. Syphilis B. Malaria fever C. Tuberculosis D. Acquired immunodeficiency Syndrome.

48. Sources of air pollutants are
 A. industrial chimneys, burning fossil oils and river dams B. sulphur dioxide, acid rain and pesticides C. sulphur mines, vehicle exhausts and aerosols D. sewage, smoke and old vehicles.

49. Fertilizers are lost from the soil through
 A. sheet erosion and evaporation B. leaching, underground seepages and run-off C. sheet erosion, gully erosion and wind erosion D. wind erosion and heavy rainfall.

50. Nitrogen-fixing micro-organisms in leguminous plants live symbiotically in the
 A. root nodules B. tap roots C. branch roots D. root hairs.

Biology 1992

1. The organelle involved in tissue respiration is the
 A. endoplasmic reticulum B. ribosome C. golgi body D. mitochondrion.
2. A tissue can best be defined as.
 A. an aggregate of similar cells B. an aggregate of cells performing a similar function C. an aggregate of similar cells performing the same function D. a mixture of different cell types performing the same function.
3. Which of the following correctly summarizes the life cycle of a fern plant?
 A. Spore → prothallus → thallus → sporangium. B. Male and female gametangia → zygospore → sporangium → spores. C. Spore → thallus → spermatozoa + ovumsporangium D. Prothallus → spermatozoid + egg cell → leafy plant → sporangium spore.
4. A major difference between platyhelminthes and coelenterates is that platyhelminthes
 A. are multicellular B. have developed a mesoderm C. reproduce sexually D. reproduce asexually.
5. The essential structural difference between Hydra and tapeworm is that while Hydra,
 A. has tentacles, tapeworm is parasitic B. is diploblastic, tapeworm is triploblastic C. has a mouth, tapeworm feeds by suckers D. has mesoderm, tapeworm has mesogloea.
6. The flowering period of plants in a habitat is determined by the
 A. duration of sunlight B. intensity and duration of rainfall. C. relative humidity of the atmosphere D. temperature of the habitat.

Use the figure below to answer question 7 and 8.

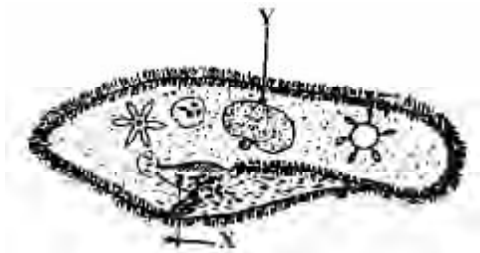

7. The structure labeled X is used by the organism in the same way as man uses his
A. oesophagus B. trachea C. stomach D. intestine.
8. The structure labelled Y is the
A. food vacuole B. nucleolus
C. macronucleus D. contractile vacuole.
9. Which of the following insects undergoes incomplete metamorphosis?
A. mosquito B. Termite C. Housefly D. Moth.
10. An onion is a bulb because it
A. has a tuberous stem B. has a reduced stem and thick fleshy leaves C. has adventitious roots D. bears many buds at the nodes.
11. The flow of air and water in or out of the mesophyll layer of a leaf is controlled by the
A. stomata B. lenticels C. air spaces D. guard cells.
12. Fungi are heterotrophic because they
A. have no leaves B. lack roots C. are filamentous D. lack of chlorophyll.
13. The major site of photosynthesis in the leaf is the
A. palisade parenchyma B. mesophyll parenchyma C. upper epidermis D. lower epidermis.
14. 5cm³ dilute sodium hydroxide solution and 5cm³ one percent copper sulphate solution are added to a solution of food specimen. The purple colour which is observed shows the presence of
A. glucose B. starch C. fat D. protein.
15. The blood vessel which carries blood from the alimentary canal to the liver is the
A. hepatic artery B. hepatic vein C. hepatic portal vein D. mesenteric artery.
16. Gaseous exchange in Aves occurs in the
A. tracheoles B. bronchi C. air sacs D. trachea.
17. In the absence of oxygen, the pyruvic acid produced during glycolysis is converted to CO₂ and
A. water B. glycerol C. ethanol D. citric acid.
18. The excretory organ in insect is the
A. kidney B. malpighian tubule C. flame cell D. nephridium.

Use the figure below to answer questions 19 and 20.



19. The structure labelled 5 is the
A. sweat gland B. sebaceous gland C. blood vessel D. nerve fibre.
20. Melanin and keratin are produced in the part labelled
A. 2 B. 3 C. 4 D. 5.
21. The bone of the neck on which the skull rests is known as the
A. odontoid process B. axis C. atlas D. occipital condyle.
22. Which enzymes are contained in the pancreatic juice?
A. Ptyalin, lipase and pepsin B. Maltase, erepsin and trypsin. C. Rennin, surcrase and lipase D. Amylase., lipase and trypsin.

Use the figure below to answer questions 23 and 24.



23. The part labeled 3 is the
A. cartilage B. ligament C. synovial fluid D. bone.
24. The function of the part labeled 1 is to
A. secrete a fluid which lubricates the joint B. attach muscles to the bones at the joint C. bend the bones at the joint D. hold the joint in place.
25. Double fertilization in higher plant is significant because it ensures the
A. formation of a fertile embryo B. formation of a fertile embryo and the endosperm C. development of the seed D. development of the fruit.
26. In mammalian development, the function of the yolk is to
A. supply nutrients to the embryo B. acts as the shock-absorber to the foetus C. supply air to the embryo D. facilitate the process of excretion in the foetus.
27. Hydrogeal germination scharacterized by the
A. emergence of the plumule out of the ground B. provision of nourishment by the endosperm C. elongation of the hypocotyl D. elongation of the epicotyl.

28. Fruits which develop without fertilization of the ovule are
 A. false B. multiple C. aggregate D. parthenocarpic.

Use the figure below to answer question 29 and 30

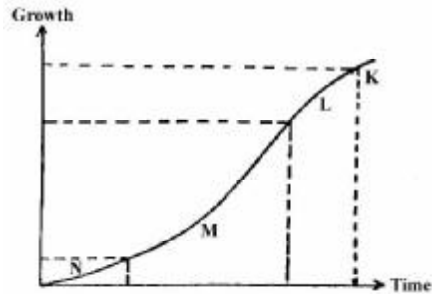

29. Which part of the curve represents the fastest rate of growth?
 A. K B. L C. M. D. N.
30. The grand period of growth is represented by
 A. N B. M C. L. D. K.
31. Neurons that receive stimuli from the body or internal organs are called
 A. sensory neurons B. efferent neurons
 C. motor neurons D. relay neurons.
32. Which of the following is true of a climax community?
 A. It persists until the environment or climate changes.
 B. It changes drastically from one year to the next
 C. It is the first stage in succession. D. It is made up of the tallest trees and the smallest animals.
33. A population is defined as a collection of similar organisms that
 A. behave in the same way B. interbreed freely
 C. are found in the same habitat D. eat the same food.
34. In typical predator food chain involving secondary and tertiary consumers, the organisms become progressively
 A. smaller and more numerous along the food chain
 B. equal in number and size along the food chain
 C. larger and fewer along the food chain D. parasitized along the food chain as consumers get bigger.

Use the figure below to answer questions 35 and 36.

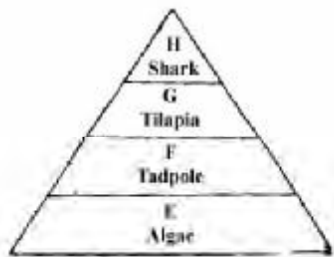

35. Which level of the pyramid has the least total stored energy?
 A. E B. F C. G D. H.
36. Which organism in the pyramid functions as a tertiary consumer?
 A. Algae. B. Shark. C. Tadpole. D. Tilapia.

37. Mangrove swamp can be found
 A. on a sea shore with flat terrain B. where a river meets the sea
 C. on a mud flat near the sea. D. where two rivers meet.
38. Soil with the finest particles is called
 A. silt B. clay C. sand D. gravel.
39. Malaria symptoms are caused by
 A. toxins released into the blood as a result of the destruction of red blood cells
 B. the multiplication of the malarial sporozoites in the liver.
 C. the invasion of the red blood cells by the trophozoites
 D. the development of merozoites into gametocytes.
40. Which of the following is true of the children of a haemophilic man who marries a woman that is not haemophilic and does not carry the trait?
 A. All their sons will be haemophilic. B. All their daughter will be haemophilic.
 C. All their daughters will be carriers. D. All their sons will be carriers.
41. A child with blood group genotype different from those of both parents and with a mother of genotype OO, can only have a father of genotype
 A. A B. B C. AB D. OO.
42. If R and r denote the genes for a character, the offspring of the cross between RR and Rr are
 A. RR, 2Rr, rr B. 2RR, 2rr C. 2RR, 2Rr D. 4Rr.
43. A mammal with red fur and long ears was crossed with another having white fur and short ears. If the offspring had red fur and short ears, then the
 A. characters are linked B. characters are not linked
 C. parents are related D. parents are not related.
44. Pawpaw seeds collected from a tree with many desirable agronomic qualities did not give rise to plants of desirable characters as the parent because
 A. seeds are not reliable for propagating plants
 B. uncontrolled out-crossing can introduce unwanted variability
 C. vegetative propagation is the best form of reproduction for all crops
 D. seeds were not physiologically mature at harvest.
45. Women do not suffer from colour blindness
 A. because the trait is sex-linked B. only men are colour blind
 C. the genes are recessive and sex-linked D. the genes occur on both the X and Y chromosomes.
46. The hereditary material of the cell is
 A. the RNA B. protein C. the DNA D. carbohydrate.
47. An example of plant adaptation to a xerophytic environment is represented by the development of
 A. fleshy tissues and reduced leaves B. broad canopy and extensive surface root system
 C. thick barks and broad leaves D. rough leaves and shallow root system.

48. Which of the following factors is LEAST likely to affect the animals living in a fresh water habitat?
 A. Turbidity B. Temperature C. pH D. Salinity.
49. The theory of natural selection was developed by
 A. Lamarck and Darwin B. Darwin and Wallace
 C. Wallace and Mendel D. Mendel and Lamarck.
50. Fossil records found in sedimentary rocks offer some explanation for the theory of evolution because
 A. the deposits have remains of organisms characteristic of when they were formed
 B. different strata have remains of organisms of the same kind C. only organisms with strong parts are fossilized D. most animals and plant fossils bear little resemblance to present day living specimens.

Biology 1993

1. On what structures are the units of inheritance situated?
 A. Golgi bodies B. Ribosomes C. Chromosomes
 D. Endoplasmic reticulum.
2. Production of naked seeds is a distinctive feature of the group of plant called?
 A. grasses B. conifers C. legumes D. palms.
3. In which of these features do bryophytes differ from pteridophytes?
 A. Absence of flower B. Alternation of generation
 C. Dependence on water for reproduction
 D. Presence of a vascular system.
4. Which of the following organs or cell components are common to both the sporophyte and the gametophyte of a fern?
 A. Rhizoids B. Roots C. Chloroplasts D. Leaves.
5. In which of the following organisms does a single cell perform all the function of movement, nutrition, growth, excretion and photosynthesis?
 A. Paramecium B. Euglena C. Amoeba. D. Spirogyra.
6. In which of the following organisms would glycogen be stored?
 A. Spirogyra. B. Chlamydomonas. C. Rattus
 D. Magnifera.
7. The most successful group of animals in terms of diversity of species is
 A. mollusca B. arthropoda C. mammalia
 D. playthelminthes.
8. Flame cells are the
 A. excretory system of worms B. excretory and respiratory system of flatworms
 C. excretory system of flatworms D. excretory system of flatworms.
9. The spores of mucus are dispersed by
 A. water B. wind C. insects D. explosive mechanism.

Use the figures below to answer questions 10 and 11

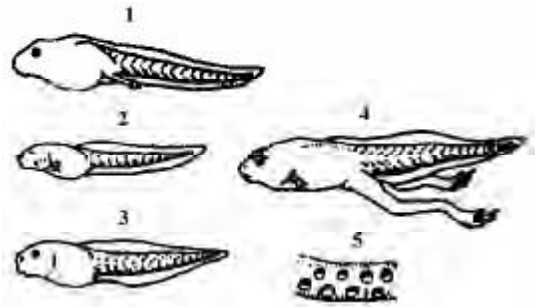

10. Which of the following is the correct order of the development stages?
 A. 1 à 2 à 3 à 4 à 5 B. 5 à 1 à 3 à 2 à 4
 C. 2 à 1 à 3 à 4 à 5 D. 5 à 3 à 2 à 1 à 4.
11. Stage 3 breathes
 A. with the lungs B. with the external gills C. with the internal gills D. through the skin.
12. The butterfly is of great economic importance because
 A. of its use in scientific studies B. it sucks nectar from flowers
 C. it adds to the beauty of the environment D. it pollinates flower of crops and other plants.
13. Manufactured food in the plants is transported through the
 A. xylem B. phoem C. cambium D. cortex.
14. Interveinal chlorosis is normally associated with the deficiency of
 A. magnesium B. potassium C. iron D. calcium.
15. Osmic acid boiled with a solution of food substance gave a black precipitate. This indicated the presence of
 A. fats and oils B. proteins C. amino acids D. starch.

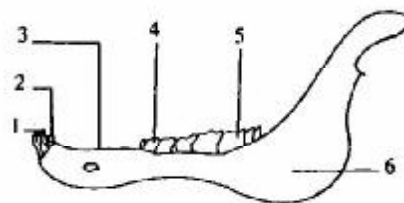

16. Which of the labeled parts is the diastema?
 A. 2 B. 3 C. 4 D. 6.

17. The lower jaw is typical of a
A. sheep B. rabbit C. dog D. cat.
18. The end products of the digestion of fats and oils in mammals are
A. maltose and fatty acids B. amino acids and glucose
C. fatty acids and fructose D. fatty acids and glycerin.

Use the diagram below to answer questions 19 and 20

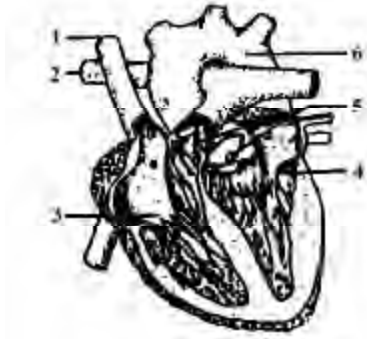

The mammalian heart

19. Blood is pumped into the right ventricle by the contraction of the auricle wall through
A. 1 B. 3 C. 5 D. 6.
20. After circulation in the lungs, the blood returns to the left auricle through
A. 1 B. 4 C. 5 D. 6
21. The main function of blood in mammals is to transport
A. excretory materials from tissues B. carbon dioxide from lungs to tissues
C. digested food from all the body tissues. D. oxygen to the lungs.
22. Members of the phylum Protozoa use the contractile vacuole
A. to remove excess food B. for movement
C. for digestion D. to remove excess water.
23. The response shown by the tips of the root and shoot of a plant to the stimulus of gravity is
A. haptropism B. phototropism C. hydrotropism
D. geotropism.
24. Which of the following is the correct order of the vertebrae along the spinal column? 4
A. Axis → atlas → thoracic → lumbar → cervical → sacral
B. Atlas → cervical → axis → thoracic → lumbar → sacral.
C. Atlas → axis → cervical → thoracic → lumbar → sacral
D. Axis → cervical → thoracic → sacral → lumbar.
25. Which of the following is TRUE of the process of conjugation in Paramecium?
A. Micronucleus disintegrates. B. Each ex-conjugant divides only once.
C. Macronucleus undergoes division D. Each micronucleus divides twice.
26. The bright colours of the comb and feathers in the peacock are for
A. sex differentiation B. beauty C. courtship
D. defence.

27. The main function of the petal of a flower is to
A. attract pollination agents. B. protect the flower while still in bud
C. serve as landing stage for insects D. protect the inner parts from desiccation.
28. In the mammal, the autonomic nervous system consists of
A. sympathetic and parasympathetic systems. B. brain and spinal nerves
C. brain and cranial nerves D. spinal cord and spinal nerves.

Use the diagram below to answer questions 29 and 30

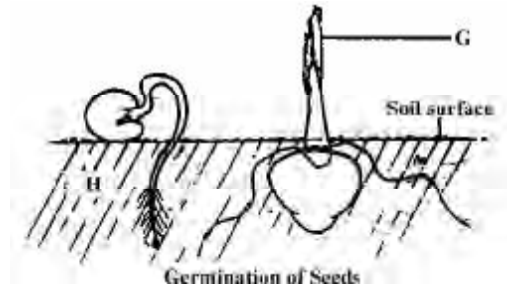

29. In H, the cotyledons are carried above the soil because
A. the epicotyl grows faster than the hypocotyl
B. the hypocotyl grows faster than the epicotyl
C. both grow at the same rate
D. the epicotyls out grows the radicle.
30. The function of the structure labelled G is to
A. carry out initial photosynthesis for the seedling
B. protect the young leaves from mechanical damage
C. protect the young leaves from sunlight.
D. protect the young leaves from insect.
31. When it is cold, the blood vessels of the skin
A. dilate to increase the amount of blood flowing to the skin
B. constrict to reduce the amount of blood flowing to the skin.
C. dilate to reduce the amount of blood flowing to the skin
D. constrict to increase the amount of blood flowing to the skin.
→ →
32. Which path does sound entering the human ear follow?
A. Oval window → ossicles → ear drum B. ear drum → oval window → ossicles.
C. Ear drum → ossicles → oval window. D. Ossicles → ear drum → oval window.
33. What would happen to a man whose pancreas has been surgically removed?
A. The level of blood sugar would increase.
B. The glycogen content of the liver would increase.
C. His blood pressure would decrease. 4
D. His weight would increase appreciably.
34. Carnivorous plants are usually found in area
A. which are deficient in nitrate B. which are deficient in oxygen
C. with low pH D. where insects are abundant.
35. What is the term used to describe the sum total of biotic and abiotic factors in the environment of the organism?
A. Habitat. B. Biome. C. Ecosystem D. Ecological niche.

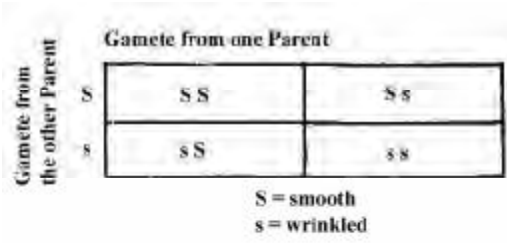
36. Important abiotic factors which affect all plants and animals in the habitat are
 A. temperature and turbidity B. rainfall and relative humidity C. salinity and wind direction
 D. temperature and rainfall.
37. The most important physical factor which affects an organism living in the intertidal zone of the seashore is
 A. pH B. salinity C. wave action D. temperature.
38. At which trophic level would the highest accumulation of a non-biodegradable substance occur?
 A. Primary producers. B. Tertiary consumers. C. Primary consumers. D. Secondary consumers.
39. Two organisms of different species, living in close association but not dependent on each other are referred to as
 A. parasites B. commensals C. symbiots D. autotrophs
40. Which of the following instruments is NOT used in measuring abiotic factors in any habitat?
 A. Microscope B. Thermometer C. Hygrometer D. Wind vane.
41. Plants adapted for life in salty marsh are called
 A. hydrophytes B. xerophytes B. halophytes
 D. epiphytes.
42. Which group plants would be the first colonizers in an ecological succession changing rocks to soil?
 A Mosses. B. Ferns C. Lichens D. Grasses.
43. Soil fertility can be conserved and renewed by
 A. yearly mono cropping B. crop rotation and cover crops C. bush burning to remove unwanted debris
 D. avoiding artificial manures.
44. What ecological condition favors the breeding of black flies?
 A. Fresh water habitat B. Water in ponds and swamps
 C. Water in small containers D. Fast flowing stream.
45. Carbon monoxide poison tissues by
 A. constricting the blood vessels B. killing the cells
 C. combining with haemoglobin D. rupturing the blood vessels.
46. Which of the following is an example of discontinuous variation observed in man?
 A. Skin colours B. Tongue rolling C. Body weight
 D. Height.
47. During blood transfusion, agglutination may occur when
 A. Contrasting antigens react with contrasting antibodies B. Similar antigens react with
 C. two different antigens react with each other
 D. two different antibodies react with each other.
48. 
- In the illustration above, the genotypes of the offspring are
 A. 1 heterozygous smooth : 2 homozygous smooth : 1 wrinkled B. 1 homozygous smooth : 2 heterozygous smooth 1 wrinkled
 C. 2 homozygous smooth : 2 wrinkled
 D. 3 heterozygous smooth : 1 wrinkled
49. Cold blooded animals are referred to as
 A. poikilothermic B. homiothermic
 C. polythermic D. homeostatic
50. Which of the organism has lost the pentadactyl limb structure?
 A. Bat B. Fish C. Frog D. Pigeon.

Biology 1994

1. The membrane surrounding the vacuole in a plant cell is called the
 A. plasmalemma B. tonoplast C. nuclear membrane
 D. endoplasmic reticulum.
2. The smallest living organisms which share the characteristics of both living and non-living matter are
 A. bacteria B. fungi C. viruses D. protozoa.
3. Green plants are distinguished from other living organisms by their ability to
 A. make use of water B. make use of oxygen
 C. respond to sunlight D. manufacture their own food.
4. The soil swallowed by the earthworm to form the worm cast is ground up in the
 A. clitellium B. prostosium C. mouth D. gizzard.
5. Which is the correct order in an evolutionary sequence for the following plant groups?
 A. Bacteria → ferns → algae → mosses → seed plant.
 B. Bacteria → ferns → mosses → algae → seed plants
 C. Bacteria → algae → mosses → ferns → seed plants
 D. Bacteria → mosses → algae → ferns → seed plants.
6. In Amoeba, osmoregulation is carried out by the
 A. pseudopodium B. food vacuole C. contractile vacuole D. nucleus.

Use the diagram below to answer questions 7 and 8.

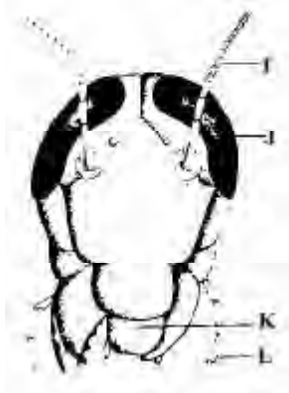

Head of a cockroach

7. The part used for feeling is labelled
A. I B. J C. K D. L.
8. The mouth part of the insect is adapted for
A. biting and chewing B. suckling and chewing
C. biting and sucking D. piercing and sucking.
9. Which of the following combinations differentiates a bony fish from a cartilaginous fish? I Presence of gills. II Absence of gill slits III Possession of bony skeleton IV Possession of laterally compressed body V Possession of dorso ventrally compressed body
A. I, II and II. B. I, III and IV. C. II, III and IV. D. II, III and V.
10. Which is the most important adaptation of a bony fish to life in water?
A. The possession of a streamlined shape
B. The presence of overlapping scales
C. The covering of the body by thin film of shine.
D. The possession of a caudalfin.

Use the diagram below to answer questions 11 and 12

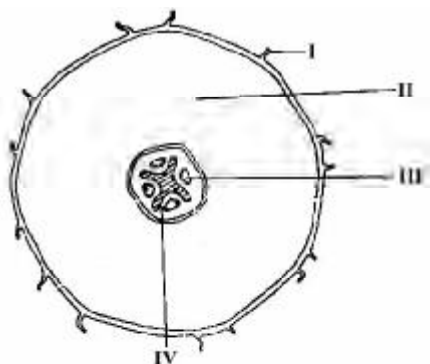

11. Which of the labeled part allows for efficient absorption of water and mineral?
A. I B. II C. III. D. IV.
12. Starch is usually stored in the part labelled
A. I. B. II. C. III. D. IV.

13. The failure of transport and respiratory systems in plants as well as the presence of reddish colour in stems and leaves result from the deficiency of
A. magnesium B. nitrogen C. potassium D. phosphorus.
14. The dental formula $\begin{matrix} 1 & 3 & 1 & 4 \\ 3 & 1 & 4 & 3 \end{matrix}$ is that of a
A. goat B. rabbit C. man D. dog
15. The nitrifying bacteria, Nitrosomonas, convert ammonia to
A. nitrites B. nitric acid C. nitrates D. nitrous oxide.
16. The activity of ptyalin of ptyalin is likely to decrease with an increase in the concentration of
A. oxygen B. starch C. protein D. acid.
17. The phloem parenchyma is sometimes used for
A. food storage B. supporting the stem C. production of the sieve tube D. transporting water.
18. The process by which a red blood cell placed in distilled water absorbs until it bursts and releases its contents into the surrounding is known as
A. osmosis B. plasmolysis C. turgidity D. haemolysis.

Use the diagram below to answer questions 19 and 20.

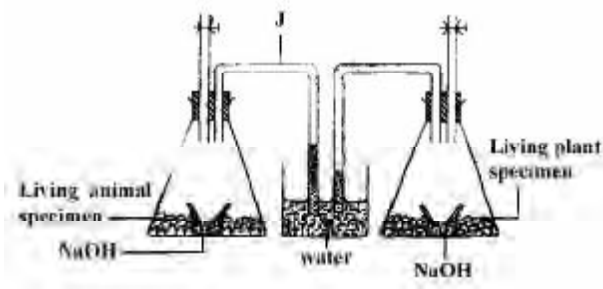

19. The most appropriate title for the set up is
A. quantitative measurement of respiration in plants and animals B. measurement of respiratory rates in living organisms C. comparison between photosynthesis and respiratory D. comparison of respiratory rates in plants and animals.
20. The part labeled J is called
A. porosimeter B. porometer C. manometer D. auxanometer.
21. A circulatory system that does not allow mixing of oxygenated and de-oxygenated blood in mammalian heart is referred to as
A. open B. haemocoelic C. single D. closed.
22. Which of the following waste products in plant is excreted through the stomata and lenticels?
A. Carbondioxide B. Alkaloids. C. Tannins D. Anthocyanins.

Use the diagram below to answer questions 23 and 24.

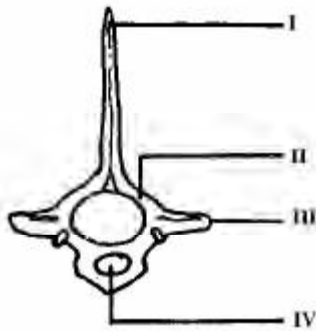

23. The vertebra illustrated is
A. lumbar B. thoracic C. caudal D. cervical.
24. The neural arch is labelled
A. I. B. II C. III D. IV.
25. In animals, meiosis comes
A. after fertilization B. after every mitotic division
C. before fertilization D. before every mitotic division.
26. The fleshy base of a flower to which the different floral parts are attached is known as
A. calyx B. sepals C. thalamus D. hypothalamus.
27. When a short-sighted person views a distant object without spectacles, the image is formed
A. on the retina B. in front of the retina C. behind the retina
D. on the blind spot.
- 28.

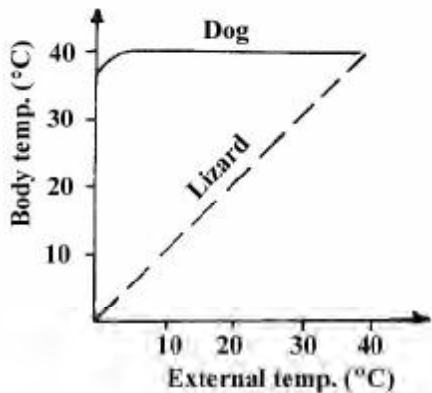

The graph shows the relationship between the body and atmospheric temperatures for dog and lizard. What is the most appropriate deduction that could be made from the graph?

- A. Lizards are more likely to survive hazards than dogs.
B. Both animals maintain a constant body temperature
C. The dog's body temperature is independent of the external temperature. D. The lizard's body temperature varies with that of the dog.
29. The part of the brain that controls heart beat and breathing is the
A. olfactory lobe B. cerebellum
C. cerebral hemisphere D. medulla oblongata.

Use the list of ecological constituents below to answer questions 30 and 31

1. Mango 2. Speargrass 3. Goat 4. Sheep
5. Temperature 6. Beans 7. Rock 8. Water.

30. Items 1-4 can be regarded as
A. a population B. a community C. an ecosystem
D. a niche.
31. The physical factors are represented by
A. 1,5,6 B. 4,5,7, C. 5,7,8, D. 6,7,8.
32. Which of the following sets is made up of decomposers?
A. Rhizopus, earthworm and protozoa
B. Mushroom, rhizopus and bacteria
C. Bacteria, earthworm and nematodes
D. Earthworm, sedges and platyhelminthes.
33. The correct order in a food chain involving the organisms (1) Grasses, (2) Hawks, (3) Snakes, (4) Grasshopper, (5) Lizards is
A. 1 2 3 4 5 B. 5 4 3 2 1 C. 1 4 5 3 2 D. 3 2 4 5 1.
34. The organisms with the least number of individuals in a pyramid of numbers are the
A. secondary consumers B. tertiary consumers
C. primary producers D. primary consumers.

Use the list of biomes below to answer questions 35 and 36.

1. Desert 2. Rain forest 3. Southern Guinea savannah 4. Northern Guinea savannah.

35. A biome with a low annual rainfall, few scattered trees within dense layer of grasses and found in Kano and Katsina States is
A. 1 B. 2 C. 3. D. 4
36. A biom where small mammals undergo aestivation for long periods is
A. 1 B. 2 C. 3. D. 4
37. Ecological succession ends with the formation of a stable
A. nich B. population C. pioneer community
D. climax community
38. In a drought situation, plants suffer from water stress which could result in
A. reduced biochemical activities B. enhanced chemical activities
C. enhanced microbial activities
D. reduced phototropic activities.
39. The water-retention capacity of a soil indicates its
A. fertility B. capillarity C. aeration level D. pH level.
40. People who suck petrol with their mouths run the risk of increasing in their blood the concentration of
A. iron B. lead C. calcium D. magnesium.
41. The differences and similarities among living things account for
A. diversity B. stability C. competition D. evolution.

42. People with sickle-cell anaemia have haemoglobin
 A. S and are homozygous recessive
 B. A and are heterozygous recessive
 C. S and are heterozygous recessive
 D. A and are homozygous recessive.
43. In the gene locus for eye colour in humans, the allele for brown eyes is dominant over the allele for blue eyes. If a homozygous brown-eyed girl has a brother with blue eyes, what are the likely phenotypes of their parents' eye colour? (Eye colour is not a sex-linked trait).
- A. Both parents have blue eyes. B. Their father has blue eyes and their mother has brown eyes.
 C. Both parents have brown eyes. D. Their mother has blue eyes and their father has brown eyes.
44. If a woman's genotype is Tt Qq Rr, what would be the gene content of her eggs?
 A. TQ^r tqr B. TQR, tqr C. TqR, tQR D. tQr, TQR.
45. The sex-linked defect in which very slight cut produces severe bleeding is known as
 A. anaemia B. anorexia C. haemophilia D. haemolysis
46. A man who has the trait for colour blindness marries a normal woman. What percentage of their children would be sufferers, carriers and normal respectively?
 A. 25% and 50% B. 25%, 50% and 25%
 C. 50%, 25% and 25% D. 25%, 37.5% and 37.5%.
47. Breathing root is an adaptation for survival in the
 A. mangrove swamp B. desert C. arboreal habitat D. savanna.
48. Red coloration on the head of a male lizard helps it to
 A. mark its territory B. camouflage in the environment
 C. secure its mate D. defend itself.
49. A phenomenon by which an animal goes into a state of dormancy during the dry season is called
 A. hibernation B. aestivation C. incubation
 D. deactivation.
50. The anatomical evidence usually used in support of all evolutionary relationship among whales, humans, birds and dogs is the possession of
 A. thick skin B. pentadactyl limb C. tail
 D. epidermal structures.

Biology 1995

1. Which of the following does a virus have in common with animal cells?
 A. Nucleus B. DNA C. Glycogen D. Cytoplasm.
2. Which of the following organelles are likely to be present in cells that are actively respiring and photosynthesizing?
 A. Nucleolus and centrioles B. Mitochondria and chloroplast. C. Lysosomes and ribosomes
 D. Golgi apparatus and endoplasmic reticulum.
3. One common characteristic of fungi, algae, mosses and ferns is that they
 A. show alternation of generations B. reproduce sexually by conjugation C. produce spores that are dispersed D. possess chlorophyll II in their tissues.
4. Protein-like bodies are borne on the part labelled
 A. II B. III C. IV D. V.
5. The sexual reproductive functions is performed by the part labelled
 A. I B. II C. IV D. V
6. Which of the following is transmitted through mosquito bite?
 A. Filariasis. B. Typhus. C. Plague. D. Schistosomiasis.
7. Which of the following insects lays its eggs in horny, purse-like cases?
 A. Mosquito. B. Butterfly. C. Termite. D. Cockroach.
8. In which of the following vertebrates does the skin function as a respiratory surface?
 A. Rat. B. Lizard. C. Fish D. Frog.
9. Birds maintain their body temperature with the help of their
 A. blood which maintains constant temperature
 B. feathers which cover the body C. skin which conserves moisture D. veins which transport fluid of constant temperature to all body tissues.
10. Secondary thickening in dicotyledonous stem is controlled by the
 A. xylem B. phloem C. cambium
 D. pericycle.
- Use the diagram below to answer question 4 and 5**

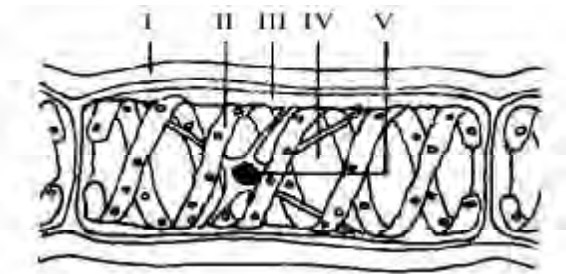

11. $2H_2O - 2H_2 + O_2(g)$. The equation above represents a part of the light stage of photosynthesis. Which of the following must be present for this reaction to occur?
A. Enzyme and light energy. B. carbon dioxide and light energy. C. Light energy and chlorophyll II. D. Chlorophyll and enzyme.
12. In an experiment to investigate the effect of nitrogen on the growth of plants, the substrate should be a medium of
A. washed and sand B. saw dust C. cow dung D. clay soil.
13. Which vitamin plays an important role in blood clotting?
A. Vitamin A B. Vitamin K C. Vitamin B₁₂ D. Vitamin C.
14. The mammalian organ which acts both as a digestive and as an endocrine organ is the
A. oesophagus B. liver C. pancreas D. spleen.
15. Which of the following is NOT involved in the transport of substances in the body?
A. Lymph B. Plasma C. Leucocytes D. Erythrocytes.
16. The end product of glycolysis in plants and animals is
A. pyruvic acid B. citric acid C. aspartic acid D. malic acid.
17. During respiration, air circulates round plant tissues via the
A. lenticels B. stomata C. guard cells D. intercellular spaces.
18. The excretory structure in the earthworm is the
A. malpighian tubule B. flame cell C. nephridium D. kidney.
19. During the bending of the arm, the biceps muscle
A. contracts and the triceps muscle relaxes
B. relaxes and the triceps muscle contracts
C. and the triceps muscle contract D. and the triceps muscle relax.
20. When a healthy shoot of a flowering plant is illuminated from one side, auxins accumulate on the
A. non-illuminated side of the shoot
B. illuminated side of the shoot C. upper side of the shoot D. lower side of the shoot.

Use the diagram below to answer questions 21 and 22.

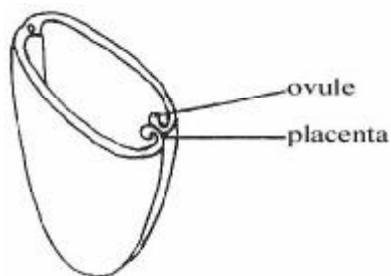

21. The type of placentation shown is
A. axial B. marginal C. parietal D. central
22. An example of a plant having the placentation shown is
A. allamander B. hibiscus C. water lily D. pride of Barbados.

23. The term caryopsis is used to describe a fruit in which the
A. testa and pericarp are separate B. seed and endocarp are fused C. testa and pericarp are fused D. seed coat and fruit wall are impermeable.
24. The sex of a foetus is determined during
A. meiosis B. copulation C. fertilization D. placentation.
25. Biological growth refers strictly to an increase in the
A. protoplasm of an organism B. number of organisms C. size of an organism D. development of form.
26. The process of walking is under the control of the part of the brain called
A. optic lobe B. olfactory lobe C. cerebellum D. medulla oblongata.
27. The gland directly affecting metabolic rate, growth and development is known as
A. adrenal gland B. thyroid gland C. mammary gland D. parathyroid gland.

Use the diagram below to answer questions 28 and 29

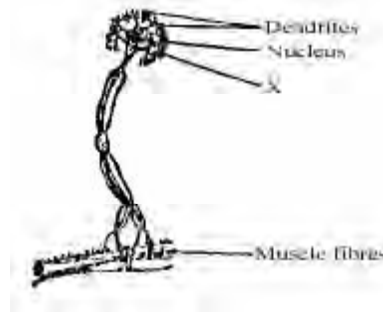

28. The diagram represents
A. sensory neurone B. relay neurone C. afferent neurone D. motor neurone.
29. The part labelled X is the
A. axon B. cell body C. terminal dendrites D. synapse.
30. Which of the following ions is involved in the conduction of the nerve impulse?
A. Ca^{2+} B. K^+ C. H^+ D. Mg^{2+} .
31. The depth of illumination in a water body can be measured with a
A. photometer B. secchi disc C. hydrometer D. anemometer.
32. In a food chain involving a primary producer, a primary consumer as well as a secondary consumer, the sharing of trophic energy is in the form that the
A. primary consumer has more energy than the primary producer B. secondary consumer takes up all the energy contents of the primary consumer C. energy is shared equally between the three groups of organism. D. secondary consumer gets only a small portion of the energy contained in the primary producer.

33. In spite of the removal of carbon dioxide from the atmosphere, its amount remains more or less constant because
 A. it is produced by green plants during photosynthesis. B. it is produced during respiration by animals C. it is absorbed in ocean water D. green plants release it during the day.
34. In a tropical rain forest, non-epiphytic ferns and fern allies occur as
 A. middle storey species B. upper storey species C. shade-loving species D. emergent species.
35. Colonization of a bare rock surface is termed
 A. evolution B. speciation C. primary succession D. secondary succession.
36. Which of the following is a measure for the control of bilharzias?
 A. Cutting low bushes around homes
 B. Application of molluscicides in water bodies
 C. Screening windows and doors with mosquito nets.
 D. Application of herbicides in water bodies.
37. Some of the diseases caused by bacteria are
 A. tuberculosis, gonorrhoea and syphills
 B. tuberculosis, gonorrhoea and AIDS
 C. Poliomyelitis, syphilis and gonorrhoea
 D. AIDS, cholera and tuberculosis.
38. Environmental pollutants which can work through the media of water, soil and air include
 A. carbon monoxide B. noise
 C. sulphur (IV) oxide D. smoke.
39. Human height is an example of a feature which depends on both
 A. genotype and phenotype B. genetic and environmental factors
 C. mother's genotype and environmental factors. D. phenotypic and environmental factors.
40. A person with type O blood can donate to a patient with type A because the donor's blood
 A. lacks antigens B. lacks anti-A antibodies
 C. lacks anti-B antibodies D. has both anti-A and anti-B antibodies.
41. The DNA molecules is a chain of repeating
 A. nucleosides B. nitrogenous bases
 C. sugar Sphosphates D. nucleotides.
42. The specific number of chromosomes in each somatic cell is represented by
 A. 2^N B. 23 C. 2N D. N.
43. A man with blood group A is married to a woman with blood group A. Which of the following group combinations is possible if the family has three children?
 A. B, A, AB. B. O,A,B. C. B, AB, AB.
 D. A,O,A.
44. The F_1 of a cross between a tall and a dwarf plant was tall The F_1 was advanced to F_2 . How many of 120 F_2 plant will be dwarf?
 A. 30 B. 60 C. 90 D. 120.
45. The sons of a colour-blind woman will be colour blind regardless of the state of the father because
 A. the egg determines the phenotype of the son
 B. sons inherit the sex chromosomes of their mothers
 C. the father's sex chromosome is weaker in sons
 D. sex-linked traits express dominance in females.
46. The slender, long and slightly curved beak of the sun-bird is an adaptation for feeding on
 A. nectar B. small seeds C. big seeds D. insects.
47. Scales on reptiles are a feature for
 A. conserving water B. conserving food C. protecting the skin D. locomotion.
48. The colour of the ventral surface of a fish is lighter than that of the dorsal. This is mainly
 A. an adaptation for moment B. an adaptation for camouflage
 C. for attracting mates D. for regulating body temperature.
49. The least evidence in support of the theory of evolution is provided by the study of
 A. anatomy B. ecology C. geology D. embryology.8
50. From which group of animals are the mammals generally believed to have most recently evolved?
 A. Reptiles. B. Fishes. C. Amphibians. D. Birds.

Biology 1997

Use the diagram below to answer questions 1 and 2.

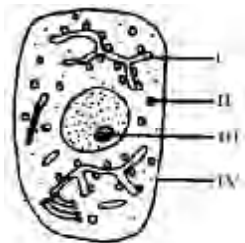

1. The structure labelled I is the
 A. Golgi body B. mitochondrion
 C. endoplasmic reticulum D. vacuole.
2. Protein is synthesized in the part labelled
 A. I B. II C. III D. IV.
3. Which of the following is the youngest plants tissue?
 A. Meristem. B. Phloem C. Epidermis. D. Xylem.

4. Virus differ from all forms of life because they
A. have a thick cell wall B. feed on waste products of other organisms C. cause infectious diseases D. require other living cells to multiply.
5. The endoblast cells found in Hydra are used for
A. reproduction B. offence and defence C. locomotion and nutrition D. food collection.
6. Annelids differ from nematodes in that they
A. exhibit bilateral symmetry B. are triploblastic C. are metamerically segmented D. possess complete digestive system.
7. Which of the following perform similar functions?
A. Ascospores and ascocarp. B. antherozoids and rhizoid. C. Sorus and indusium. D. Strobili and inflorescence.
8. In ferns, the sporophyte
A. develops from a haploid zygote B. reproduces sexually to produce spores C. is haploid and dependent on the gametophyte D. is diploid and independent of the gametophyte.
9. The group of insects that undergoes complete metamorphosis is
A. houseflies, beetles and cockroaches B. cockroaches, grasshoppers and bees C. houseflies, beetles and butterflies D. aphids, grasshoppers and butterflies.
10. The nitrogenous substance that is excreted by birds in order to conserve water is
A. ammonia B. urea C. uric acid D. nitric acid.
11. In mammals, the exchange of nutrients and metabolic products occurs in the
A. lymph B. lungs C. heart D. liver.
12. The part of the stomach nearer the gullet is called the
A. epiglottis B. cardiac sphincter C. duodenum D. pyloric sphincter.
13. Trace elements are required by plants mainly for the
A. formation of pigments and enzymes B. production of energy and hormones C. manufacture of carbohydrates D. manufacture of proteins.
16. A food substance was treated with a few drops of Sudan III solution and a red coloration was obtained. The food contained
A. protein B. starch C. fat D. mineral salt.
17. Oozing out of water from the leaves of plants in a humid environment is known as
A. transpiration B. osmosis C. pinocytosis D. guttation
18. The element that is essential for the coagulation of blood is
A. potassium B. calcium C. phosphorus D. iron.
19. Anaerobic respiration differs aerobic respiration by the production of
A. less amount of energy and water B. greater amount of energy and alcohol C. less amount of energy and alcohol. D. Greater amount of energy water.
20. Stomata pores open when there is
A. an increase in the sugar content of guard cells B. a decrease in the osmotic concentration of guard cells C. a decrease in the sugar content of mesophyll cells d. an increase in the sugar content of mesophyll cells.
21. The process of deamination is essential for the
A. digestion of protein B. secretion of bile C. formation of urea D. formation of antibody.
22. A band of connective tissue linking two bones in a joint is known as
A. tendon B. cartilage C. synovial membrane D. ligament.
23. The appendicular skeleton is composed of the pectoral girdle
A. pelvic girdle, fore and hind limbs B. pelvic girdle and fore limbs C. lumbar vertebrae and pelvic girdle D. lumbar vertebrae, fore and hind limbs.
24. The companion cells are part of the
A. pericycle B. phloem C. pith D. xylem
25. In which of the following groups of vertebrates would the largest amount of yolk be found in the egg?
A. Mammals B. Fishes. C. Amphibians. D. Reptiles.

Use the diagram below to answer questions 14 and 15.

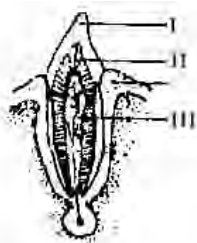

14. The part that is similar to bone is labelled
A. IV B. III C. II D. I.
15. The parts labelled I and II constitute the
A. crown B. neck C. root D. gum

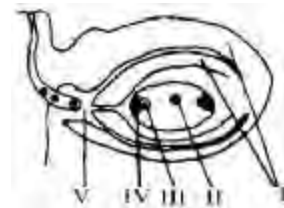

- Use the diagram below to answer questions 26 and 27.
26. The function of the part labeled V is for the passage of
A. pollen tube and pollen nucleus B. air, water and pollen nucleus C. air, antipodal cells and ovum D. synergids and egg cell.
 27. The female gamete is represented by
A. I B. II C. III D. IV.

28.



The type of vegetable reproduction illustrated in the diagram above is

- A. grafting B. adventitious bud C. sucker
D. aerial layering.

29. Coconut and oil palm fruits can be grouped as
A. berry B. legume C. Capsule D. drupe.

30. The substance that is responsible for apical dominance in plants is known as
A. gibberellin B. tannin C. auxin D. kinin.

31. The part of the brain that regulates most biological cycles in humans is
A. olfactory lobe B. optic lobe C. medulla oblongata
D. pineal body.

32. The ability of the eye to focus on both near and distant objects is termed
A. image formation B. refraction C. hypermetropia
D. accommodation.

33. The speed of wind can be measured with an instrument called
A. hydrometer B. secchi disc C. anemometer
D. wind vane.

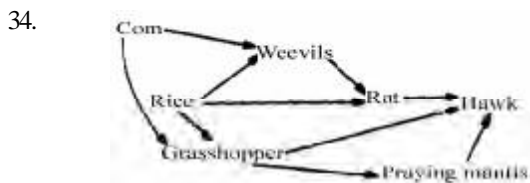

Which organism in the food-web illustrated above is an omnivore?

- A. Weevils. B. Rat. C. Hawk. D. Praying mantis.

35. Toads and lizards in an ecosystem depend on a limited quantity of food. This is an example of
A. parasitism B. intraspecific competition C. predation
D. interspecific competition.

36. Adaptive features of plants to desert conditions include
A. thick barks, succulent stems and sunken stomata
B. thin barks, succulent stems and sunken stomata
C. thin barks, air floats on stems and sunken stomata
D. air spaces in tissues, adventitious roots and thick barks.

37. The Southern Guinea Savanna differs from the Northern Guinea Savanna in that it has
A. lower rainfall and shorter grasses B. less grasses and scattered trees
C. more rainfall and taller grasses D. less arboreal and burrowing animals.

38. After a heavy rainfall and the formation of a large pond, the most likely sequence of changes in the vegetation of the pond is

- A. Euglena- water lily –Spirogyra-grass B. water lily – Spirogyra grass – Euglena C. Spirogyra – Euglena – grass – water lily D. Euglena – Spirogyra – water lily – grass.

39. In a soil sample, the relative amounts of the different soil particles can best be determined by the process of
A. filtration B. centrifugation C. precipitation
D. sedimentation.

40. Which is the most important pollutant of the marine environment in Nigeria?
A. Insecticides B. Sewage C. Oil D. Inorganic fertilizers.

41. One of the most effective ways of controlling guinea worm is by
A. treating the disease B. public enlighten men campaigns. C. accelerating rural development
D. provision of portable drinking water.

42. During binary fission in lower organisms, the nucleus is known to undergo
A. mitosis B. meiosis C. fragmentation D. mutation.

43. One reason for the success of Mendel's work is that he
A. was the first to carry out research work on modern genetics B. introduced quantitative and qualitative elements into his work C. selected two characteristics only at a time for study D. drew up his laws of inheritance based on his knowledge of chromosomes.

44. The homozygo condition $Hb^s Hb^s$ results in sickle cell anaemia whereas $Hb^A Hb^s$ has the sickling trait. What is the probability that a couple with the sickling trait will give birth to one normal child?
A. $\frac{1}{2}$ B. $\frac{1}{4}$ C. $\frac{1}{8}$ D. 0.

45. Which of the following characters is NOT sex-linked?
A. Albinism B. Baldness. C. Haemophilia
C. Colour blindness.

46. Water loss is regulated in plants and animals by both the
A. scales and the skin B. scales and the hair
C. thick leaves and the feathers D. leathery cuticle and the feathers.

47. What combination of characters should a prey develop to survive in the environment of its predator?
A. Camouflage, well developed limbs and effective vision. B. Showy colour, big body and well developed limbs. C. Camouflage, big body and effective vision. D. Show colour, well developed muscles and an acute sense of smell.

48. The three classes in a termitarium are
A. soldiers, queen and workers B. workers, soldiers and reproductives C. soldiers, workers and kings D. kings, queen and soldiers.

47. Fossil records found in sedimentary rocks offer some explanation for the theory of evolution because
 A. the deposits have remains of organisms characteristic of when they were formed
 B. different strata have remains of organisms of the same kind of only organisms with strong parts are fossilized
 D. most animal and plant fossils bear little resemblance to present day living specimens.

50. Long neck in giraffes is used illustrate the theory of
 A. use and disuse B. origin of species C. origin of life
 D. natural selection.

Biology 1998

1. The nucleus is considered the control organelle of a cell because it
 A. contains the genetic material B. contains the nuclear sap C. is bounded by the nuclear membrane
 D. is located at the centre of the cell.
2. The procaryotic cell type is characterized by a
 A. complex cytoplasm in which different regions are poorly defined B. localization of differ regions of the cell into tissues. C. collection of organelles and macromolecular complexes D. simple cytoplasm with well-defined regions.
3. The natural tendency of organism as they evolve is to
 A. decrease in size B. increase in number C. develop specialized structures D. feed indiscriminately.
4. In snails, the hard calcareous shells are secreted by the
 A. radula B. ctendium C. pneumostome D. mantle

Use the diagram below to answer questions 5 and 6.



5. The structure labelled I is formed as a result of the fusion of
 A. two pairs of nuclei B. several pairs of nuclei
 C. a pair of nuclei D. two pairs of nucleoli.
6. The special name of the part labelled II is
 A. gemetangium B. hypha C. suspensor
 D. zygospore
7. The ability of the cockroach to live in cracks and crevices is enhanced by the possession of
 A. wings and segmented body B. compound eyes
 C. claws on the legs D. dorso-ventrally flattened body.
8. The case of termites that lacks pigmentation is the
 A. king B. worker C. solder D. queen.

9. The structures that prevent food particles from escaping through the fish gills are called gill
 A. arches B. filaments C. rakers D. lamellae.
10. A distinguishing feature of mammals is the possession of
 A. skin B. scale C. nail D. hair.
11. Which of the following structures is capable of producing more tissues in the stem of a herbaceous flowing plant?
 A. Epidermis B. Pericycle C. Xylem D. Cambium.
12. The manufacture of carbohydrates by plants takes place only in
 A. the leaves B. the green stems C. chlorophyllous parts D. flowering plants.
13. In a water culture experiment, a plant showed poor growth and yellowing of the leaves. These may be due to deficiency of
 A. copper B. iron C. magnesium D. calcium.
14. In million's test, when the reagent is added to a protein food item, a white precipitate is produced which turns
 A. blue on heating B. yellow on heating
 C. green on heating D. red on heating.
15. Regulation of blood sugar level takes place in the
 A. pancreas B. ileum C. liver. D. kidney.
16. Unicellular organisms transport essential nutrients directly to all parts of their bodies by the process of diffusion because, they have
 A. a large volume to surface area ratio B. a large surface area to volume ratio
 C. their bodies immersed in the nutrients D. their outer membrane made of cellulose.
17. The heat of the adult frog consists of
 A. two auricles and two ventricles B. one auricle and one ventricle
 C. two ventricles and one auricles D. one ventricle and two auricles.

18. In adult mammalian blood, the cells which lack nucleus are the
 A. The diaphragm and intercostals muscles relax
 B. The thoracic cavity increases in volume
 C. The diaphragm and intercostals muscles contract
 D. The diaphragm contracts and the intercostals muscles to relax.
19. Which of the following movement occur during exhalation?
 A. the diaphragm contracts and the intercostals muscles relax.
20. In which of the following groups of animals is the Malpighian tubule found?
 A. Lizards, snakes and frogs B. Crickets, houseflies and grasshoppers C. Millipedes, centipedes and scorpions D. Earthworms, roundworms and flatworms.
21. Which of the following is not a function of the mammalian skeleton?
 A. Protection B. Respiration C. Transportation D. Support.

Use the diagram below to answer question 23 and 22.

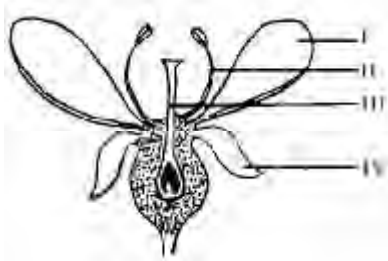

22. The ovary represented is
 A. half-superior B. inferior C. superior D. half-inferior.
23. The corolla is partly represented by
 A. I B. II C. III D. IV.
24. The most reliable estimate of growth is by measuring changes in
 A. length B. volume C. surface area D. dry weight.
25. A dry fruit formed from two or more carpels containing several seeds is a
 A. follicle B. legume C. capsule D. schizocarp.
26. The outermost embryonic membrane in the mammal is the
 A. amnion B. chorion C. allantois. D. yolk sac.
27. The small masses of nervous tissues in which many neurons have their nuclei are called
 A. dorsal roots B. ventral roots C. ganglia D. synapses.
28. A group of organisms of different species living in a particular area is described as a
 A. colony B. community C. population D. niche.
29. Which of the following is the direct consequence of transferring energy from one trophic level to another?

- A. An increase in biomass B. A decrease in the efficiency of energy conversion C. An increase in the numbers of resulting individuals
 D. A decrease in the resulting biomass.
30. The condition that encourages denitrification is
 A. low soil oxygen B. high soil nitrogen C. absence of soil bacteria D. lightning and thunderstorm.
31. A freshwater plant such as water lily can solve the problem of buoyancy by the possession of
 A. aerenchymatous tissues B. dissected leaves C. thin cell walls of the epidermis
 D. water-repelling epidermis.
32. The sequence of the biomes in Nigeria from Port Harcourt to Damaturu is
 A. estuarine '! rain forest '! Guinea savannah '! Sahel savannah B. rain forest '! Guinea savannah '! estuarine '! desert C. estuarine '! Guinea savannah '! rain forest '! Sahel savannah D. rain forest '! estuarine '! Guinea savannah '! desert.
33. Soil micro-organisms are beneficial because of their involvement in
 A. photosynthesis B. translocation C. cycling of nutrients D. respiration using soil air.
34. Which of the following groups of diseases are associated with water? I Onchocerciasis II Schistosomiasis III. Dracunculiasis IV. Elephantiasis V. Taeniasis.
 A. I,II and III B. II, IV and V C. II, III and IV D. I, II and V.
35. One of the ways in which body cells differ from gamete cells is in the
 A. type of centromeres they contain B. number of chromosome pairs they contain C. type of chromatids they contain D. number of chromosomes they contain.
36. In blood transfusion, agglutination occurs when
 A. white blood cells from two individuals meet
 B. two different antibodies meet C. two different antigens meet D. contrasting antigens and antibodies meet.

Use the diagram below to answer question 37 and 38.

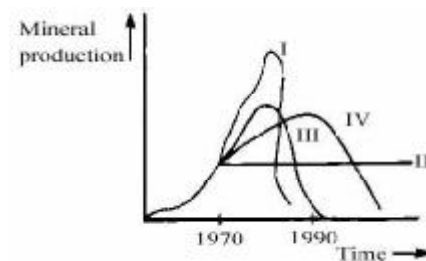

- The alternate depletion patterns of mineral resources over time.
 37. The unrestricted pattern is presented by
 A. I B. II C. III D. IV.

38. The line that represents efficient recycling combined with stringent conservation is
A. IV B. III C. II D. I.
39. After one week of life, the weights of five chicks of the same sex hatched simultaneously from the eggs the same hen and fed on the same diet were 45g, 40g, 35g, 33, and 30g. This is an example of
A. growth rate B. natural selection C. variation D. mutation.
40. The phenotype of an individual can be summed up as the
A. totality of the expressed traits B. individual's physical appearance C. individual's entire genetical make-up D. physiological traits of the individual.
41. The correct increasing order of size for the cell components responsible for heredity is
A. chromosome → DNA → nucleus → gene
B. DNA → Gene → chromosome → nucleus
C. Chromosome → nucleus → DNA → gene
D. DNA → gene → nucleus → chromosome.
42. A sex-linked character cannot be passed on directly from
A. father to son B. mother to daughter C. mother to son D. father to daughter.
43. The biological association that contributes directly to succession in a community is
A. competition B. predation C. parasitism D. commensalism.
44. The group of insects that have mouth parts adapted for both piercing and sucking is
A. cockroaches, aphids and mosquitoes B. aphids, houseflies and moths C. mosquitoes, tsetse flies and aphids D. aphids, beetles and grasshoppers.

Use the diagram below to answer questions 45 and 46.

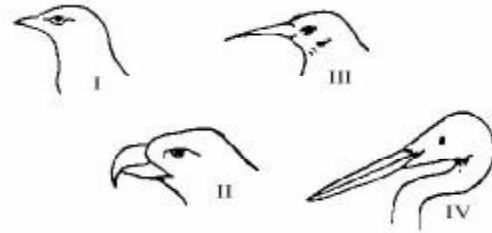

45. The bird's bill adapted for fishing is labeled
A. I B. II C. III D. IV.
46. Toes of the feet ending in a sharp, curved hook suitable for holding and tearing are most likely to belong to the bird with the bill in
A. I B. II C. III D. IV.
47. In the honey bee colony, the drones are
A. sterile males with reduced mouth parts B. sterile males with well-developed mouth parts C. fertile males with reduced mouth parts D. fertile males with well-developed mouth parts.
48. In the whistling pine leaves are reduced to brown scale and young stems are green. This is an adaptation for
A. obtaining food B. conserving nutrients C. storing water D. reducing transpiration.
49. The best explanation for the theories of natural selection is that
A. all organisms have equal capacity for survival in their habitats B. organisms have varying capacities for survival in their habitats C. organisms compete for resources and better competitors survive and thrive D. habitats allow only organisms that will not have to compete for survival.
50. The basic point of impact by changes which produce mutation is the
A. gametes B. chromosomes C. phenotype D. zygote.

Biology 1999

1. The habitat of the cysticercus of Taenia solium is
A. alimentary canal of cattle B. muscles of pig
C. alimentary canal of pig D. muscles of cattle
2. The organism that has a hydrostatic skeleton is
A. Tilapia B. Hydra C. Mosquito larva
D. Earthworm
3. These possession of scales, laying of eggs with shells and bony structure of the head are characteristics shared by
A. birds and reptiles B. fishes and birds
C. reptiles and fishes D. birds and molluscs
4. The group of Arthropods that has no antennae is the
A. crustacea B. chilopoda C. arachnida
D. dinlonoda

5. The structure that is most commonly identified in all living cells under the light microscope is the
A. mitochondrion B. chloroplast
C. nucleus D. ribosome
6. Which of the following is an organ?
A. guard cell B. liver C. xylem bundle D. blood

Use the diagram below to answer questions 7 and 8



7. The structure labelled II is used for
A. tasting B. feeling C. biting D. sucking
8. The structure labelled III represents the
A. mandible B. palp C. proboscis D. labium
9. The division of a body into two equal halves along a longitudinal plane is called
A. bilateral symmetry B. transverse section
C. radial symmetry D. longitudinal section
10. In which of the following organisms does each cell combine the function of nutrition, reproduction and growth?
A. Rhizopus B. Dryopteris C. Brachymerium
D. Spirogyra
11. The key event in the transition of the amphibians from water to land is the
A. replacement of the gills with lungs B. possession of webbed limbs
C. development of long hind limbs D. possession of tympanic membrane
12. In plant cells, the chloroplasts are located
A. inside the cell wall B. outside the protoplasm
C. within the vacuole D. within the cytoplasm
13. In woody stems, gaseous exchange take place through the
A. micropyles B. stomata C. lenticels
D. vessels
14. Substances manufactured by the leaves are transported to other parts of the plant through the
A. xylem B. companion cells C. sieve tubes
D. cambium
15. After a meal of yam has been digested the highest concentration of glucose is to be found in the
A. hepatic artery B. pulmonary vein
C. hepatic portal vein D. posterior vena cava
16. The dark reaction of photosynthesis involves
A. fixation of carbon (IV) oxide to give a six-carbon sugar
B. fixation of carbon (IV) oxide with the help of oxygen
C. use of carbon (IV) oxide to produce glucose using ATP
D. reduction of carbon (IV) oxide on chlorophyll using hydrogen
17. Mammals acclimatize to reduced oxygen content at high altitudes by
A. the stimulation of marrow to reduce the amount of erythrocytes produced
B. increasing the rate at which erythrocytes are destroyed
C. the stimulation of marrow to produce more erythrocytes
D. increasing the breakdown of the protein portion of the erythrocytes
18. The modes of nutrition in Nitrobacteri Ascaris and Homo sapiens respectively are
A. photosynthetic B. chemosynthetic, parasitic and holozoic
C. photosynthetic, parasitic and heterophytic
D. chemosynthetic, holophytic and holozoic
19. The richest sources of vitamin A are
A. palm oil and groundnut oil B. palm oil and carrots
C. rice and groundnut oil D. oranges and carrots
20. The force that holds water together in the form of a stream within the xylem tube is the
A. cohesion of water molecules to one another by hydrogen bonds
B. force of gravity attracting the water molecules through the hydrogen bonds
C. attraction between the water and xylem by osmotic force
D. normal flow of water from the ground with the help of gravitational force.
21. Yellowing of leaves is a symptom associated with deficiency of
A. iron, calcium and magnesium B. nitrogen, sulphur and potassium
C. sulphur, phosphorus and iron
D. magnesium, nitrogen and iron
22. The lymphatic system of mammals rejoins the blood circulatory system at the
A. hepatic vein B. subclavian vein C. renal vein
D. common iliac vein
23. In dissection, the rib cage of a mammal has to be opened in order to expose the
A. diaphragm B. liver C. heart D. sternum
24. Fertilization in humans usually takes place in the
A. lower part of the uterus B. upper part of the uterus
C. lower part of the oviduct D. upper part of the oviduct
25. Insects visit flowers in order to
A. feed on the nectar B. deposit pollen on the stigma
C. pollinate the flowers D. transfer pollen from anthers
26. In epigeal germination, the cotyledons are
A. carried above the ground by the elongating hypocotyls
B. pulled underground by the elongating hypocotyls
C. pulled underground by the elongating epicotyl
D. carried above the ground by the elongating epicotyl
27. Bacteria multiply rapidly by means of
A. budding B. fragmentation C. binary fission
D. spore formation
28. The correct sequence for the operation of smell in mammals is
A. chemicals → olfactory nerve endings → brain
B. dissolved chemicals → nasal sensory cell → brain
C. chemicals → mucus membrane → sensory cells → brain
D. dissolved chemicals → sensory cells → olfactory nerve → brain

Use the diagram below to answer questions 29 and 30



29. The part labelled III is for
 A. protection B. insulation C. lubrication
 D. growth
30. The structure labelled II is known as
 A. sweat gland B. lymph vessel C. blood vessel
 D. nerve ending
31. In mammals, the organ which performs digestive and endocrine functions is the
 A. liver B. pancreas C. gastric gland D. salivary gland
32. The chitin in the exoskeleton of many arthropod is strengthened by
 A. calcium compounds B. organic salts
 C. lipids D. proteins

Use the diagram below to answer questions 33 and 34

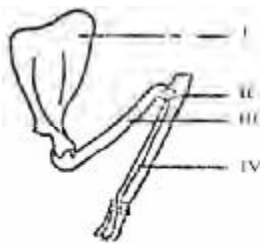

33. The structure labelled II articulates with III to form a
 A. sliding joint B. hinge joint C. pivot joint
 D. ball-and-socket joint
34. Which of the bones is the radius?
 A. I B. II C. III D. IV
35. The construction of dams may lead to an increase in the prevalence of
 A. typhoid fever, measles and yellow fever
 B. tuberculosis, leprosy and typanosomiasis
 C. guinea worm, malaria and tuberculosis
 D. malaria, bilharziasis and onchocerciasis
36. Floating microscopic heterotrophs are mostly grouped as
 A. phytoplankton B. zooplankton C. microbes
 D. nekton
37. Vaccination is carried out in order to
 A. check the production of poison
 B. increase the activity of white blood cells
 C. increase the number of red blood cell
 D. stimulate the production of antibodies
38. A soil consisting of alumina and iron (II) oxide is known as
 A. loamy soil B. clayey soil C. laterite D. podzol.
39. The sign + is used to indicate an association where an organism gains, while 0 is used where an organism is unaffected. An association indicated as + 0 is known as
 A. predation B. commensalism C. parasitism
 D. competition

Use the diagram below to answer questions 40 and 41

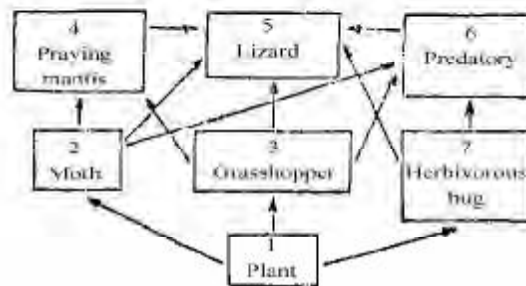

40. Primary consumers are found in
 A. 1,2,and 3 B. 1,3 and 7 C. 2,3 and 7 D. 2,4 and 5
41. The biomass is likely to increase in the sequence
 A. 1 → 2 → 4 → 5 B. 1 → 3 → 4 → 5 C. 3 → 5 → 6 → 7
 D. 5 → 4 → 3 → 1
42. Which of the following characterized the white mangrove?
 A. prop roots B. buttress roots C. breathing roots
 D. stilt roots
43. If the offspring of a cross between brown mouse (bb) and a black mouse (BB) are allowed to interbreed, how many different genotypes would result?
 A. 2 B. 3 C. 4 D. 5
44. The biological factor that is unique to each individual is the
 A. DNA B. eye colour C. blood group E. RNA
45. From an evolutionary standpoint, the older a fossil-bearing rock is the more likely it is to contain
 A. aves as opposed to amphibians
 B. invertebrates as opposed vertebrates
 C. angiosperms as opposed to algae
 D. vertebrates as opposed to invertebrates.
46. The very bright colours in some types of mushroom
 A. are a warning that they may be poisonous
 B. indicate that they are very tasty
 C. attract potential transporters of their spores
 D. perform the same function as bright colours in flowers
47. The least adaptive feature for arboreal life is that
 A. possession of four limbs B. possession of claws
 C. development of a long tail D. counter shading of coat colour
48. Which of the following is one of Lamarck's theories?
 A. some variations are more favorable to existence in a given environment than others
 B. all living organisms are constantly involved in a struggle for existence C. the size of a given population remains fairly constant
 D. new species originate through the inheritance of acquired traits.
49. The loud cry made by a brooding hen when a predator is around is meant to

- A. alert the poultry attendants
- B. attract cocks to come and fight the predator
- C. advertise the boundaries of its territory to intruders
- D. warn its chicks and other chickens of impending danger

50. The most important environmental factor which epiphytes in the rain forest compete for is
 A. water B. nutrient C. light D. space

Biology 2000

Use the diagram below to answer questions 1 and 2

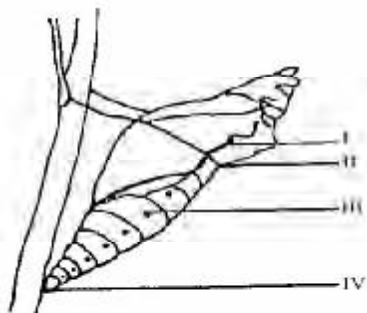

1. The part that will develop into an organ for feeling is labelled
 A. IV B. III C. II D. I
2. The part labelled II is the
 A. silk thread B. thorax C. fore wing D. anchor
3. Which of the following features are all associated with monocots?
 A. Fibrous root system, branched network of veins and one seed leaf
 B. Fibrous root system, two seed leaves and floral parts in threes
 C. One seed leaf, petals in threes or groups of threes and parallel venation of leaves
 D. One seed leaf, net-veined leaves and petals in three or multiples of three
4. The set of fins that controls steering, balancing and change of direction and pitch in fish is
 A. dorsal and anal B. pectoral and pelvic
 C. caudal and dorsal D. anal and pelvic
5. The most recently evolved structure in animals is the
 A. hair B. cilium C. scale D. feather
6. Coelom is absent in the class of animals termed
 A. mollusca B. reptilia C. arthropoda D. coelenterata
7. A characteristic of vertebrates that is unique to mammals is
 A. the presence of pentadactyl limbs
 B. parental care C. the possession of scrotum
 D. pulmonary circulation
8. The order in which organic evolution has progressed in plants is
 A. thallophyta, schizophyta, bryophyta, pteridophyta and spermatophyta
 B. schizophyta, thallophyta, bryophyta, pteridophyta and spermatophyta
 C. pteridophyta, spermatophyta, thallophyta, schizophyta and bryophyta
 D. bryophyta, pteridophyta, spermatophyta, thallophyta and schizophyta.

9. In which part of the human body does the secretion of the growth hormone occur?
 A. head region B. waist region C. neck region
 D. gonads

Use the diagram below to answer questions 10 and 11

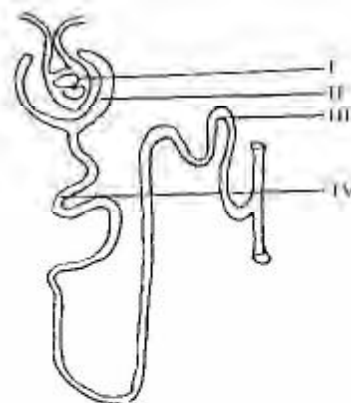

10. The parts labelled I and II make up the
 A. glomerulus B. convoluted tubules
 C. malpighian body D. bowman's capsule
11. In mammals, re-absorption of salt takes place in
 A. IV B. III C. II D. I
12. The part of the brain that controls body posture in mammals is the
 A. thalamus B. cerebrum C. spinal cord D. cerebellum
13. Peripheral arrangement of vascular tissues in dicots is a characteristic of the internal structure of the
 A. leaf B. petiole C. stem D. root

Use the diagram below to answer questions 14 and 15

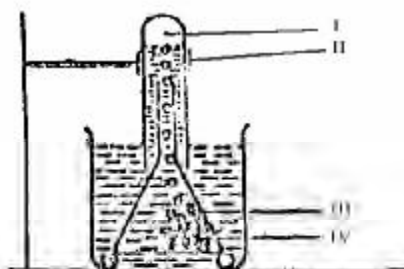

14. The substance labelled II originates from
 A. III only B. IV only C. I and IV D. III and IV

15. The gas occupying the space labelled I is
A. carbon (IV) oxide B. nitrogen
C. hydrogen D. oxygen
16. The scapula and the ischium are part of the
A. pectoral girdle B. pelvic girdle
C. appendicular skeleton D. hind limb
17. Bacteria in the large intestine of man are important in the
A. synthesis of vitamins K and B₂
B. digestion of vegetables. C. synthesis of vitamins
A and D D. absorption of water.
18. Short-sightedness can be corrected by lenses which are
A. convex B. biconvex C. plano-convex
D. concave
19. The inner ear contains two main organs, namely, the
A. eardrum and eustachian tube B. cochlea and
semi-circular canals C. oval window and ossicles
D. pinna and cochlea
20. For growth to occur in organisms, the rate of
A. food storage must be low
B. catabolism must exceed that of anabolism
C. anabolism must exceed that of catabolism
D. food storage must be high
21. The production of violet colouration, when dilute NaOH
solution is added to a solution of food substance,
followed by drops of 1 % CuSO₄ solution while making
indicates the presence of
A. protein B. carbohydrates C. fats
D. reducing sugar
22. The greatest amount of energy will be obtained by the
oxidation of 100kg of
A. meat B. butter C. sugar D. biscuits
23. The chamber of the mammalian heart with the thickest
wall is the
A. right ventricle B. left auricle C. right auricle
D. left ventricle

Use the graph below to answer questions 25 and 26.

24. Serum differs from blood plasma because it.
A. contains blood cell and fibrinogen
B. contains soluble food and mineral salts
C. lacks the blood protein fibrinogen
D. lacks blood cells and albumin

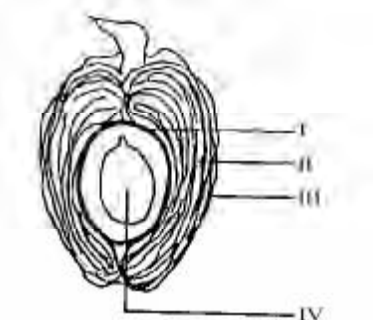

25. The part labelled II is the
A. mesocarp B. pericarp C. endocarp
D. epicarp
26. The fruit represented is mainly dispersed by
A. animals B. water C. wind D. birds
27. In an experiment to estimate the volume of air in a soil
sample using a measuring cylinder, it was found that:
Initial volume of water = p cm³ Volume of soil before
mixing with water = q cm³ Final volume of water after
adding soil = r cm³. From the data above, which of the
following deductions is correct?
A. r=p+q B. r>p+q C. q=r-p D. r<p+q
28. An ecological succession often leads to
A. an increase in species diversity B. a decrease in
species diversity C. an unstable community
D. the dispersal of species
29. Atmospheric nitrogen is converted to soil nitrogen for
plant use by
A. nitrification and combustion B. putrefaction and lighting
C. lighting and nitrification D. combustion and putrefaction
30. I High birth rate and high immigration rate II Low birth
rate and high immigration rate III Low mortality rate
and low emigration rate IV High mortality rate and high
emigration rate.
Which combination of the above can cause rapid
overcrowding in climax biotic communities and human
settlements?
A. II and III B. I and III C. I and IV D. I and II

Use the graph below to answer questions 31 and 32.

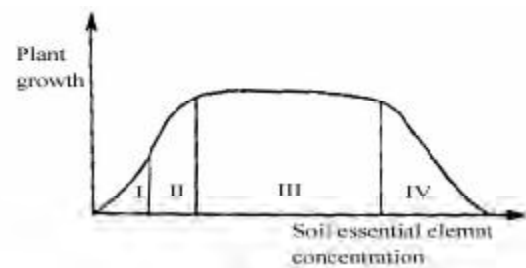

31. The soil becomes toxic to plants when the
concentration of its essential elements is in the range labelled
A. IV B. III C. II D. I
32. The range at which soil essential element concentration
is recorded for optimal plant growth is marked
A. IV B. III C. II D. I
33. Which of the following growth activities in plants is
brought about by gibberellins?
A. Rapid cell division B. Tropic response
C. Cell elongation D. Main stem elongation
34. Which of the following are adaptations of animals to
aquatic habitats?
A. Gills streamlined bodies and lateral line
B. Lateral line, streamlined bodies and lungs

- C. Gills, scaly skin and lungs
D. Gills, streamlined bodies and spiracles
35. Which of the following is an adaptation of forest species?
A. Few stomata B. Thick bark C. Buttress roots
D. Reduced leaves
36. In a food chain, each succeeding level in a forward direction, represent?
A. an increase in the number of individuals
B. a decrease in the number of individuals
C. an increase in the biomass of individuals
D. a gain in the total energy being transferred.
37. The disaster that would have the least destructive impact on animal life and balance in nature is
A. chemical pollution B. forest fires
C. oil spillage D. grasshopper pests
38. The legs and beak of an egret resemble those of the heron because they
A. both feed on fishes B. are both birds
C. occupy similar niche D. occupy the same trophic level
39. The factors that determine the distribution of vegetable zones are
A. temperature, light, rain and humidity
B. light, humidity, air and mist C. temperature, light, air and humidity D. humidity, snow, frost and dew
40. A cross between an albino female and a genetically normal male will result in offspring that are
A. all albino B. all phenotypically normal
C. all genetically normally D. half albino and half normal
41. The pollutants that contribute to the depletion of the ozone layer in the atmosphere are
A. radioactive materials B. oxides of sulphur
C. oxides of carbon D. chlorofluorocarbons
42. The surest way to combine the best qualities of both parents and the offspring is by
A. cross-breeding B. inbreeding C. selective breeding
D. pure breeding
43. Blood grouping in human beings is derived from combination of
A. two different alleles B. four different alleles
C. three different alleles D. two different genes.
44. The older fossil-bearing rocks, in contrast to the more recent ones, are more likely to contain
A. animals rather than plant remains B. invertebrates rather than birds
C. flowering plants rather than mosses D. reptiles rather than fishes
45. In a group of male Agama lizards, the one brightest head colour is the
A. dominant B. youngest C. oldest D. largest
46. Examples of water-borne and sex-linked disease are
A. taeniasis and malaria B. cholera and gonorrhoea
C. typhoid and syphilis D. dracunculiasis and haemophilia
47. The mutation theory of organic evolution was propounded by
A. Gregor Mendel B. Hugo Vries
C. Jean Lamarck D. Charles Darwin
48. A certain savanna grasshopper changes colour from green during the rainy season to brown during the dry season bush fires. The reason for these colour changes is that the
A. grasshopper is getting older
B. environment temperature is changing
C. grasshopper is avoiding predation
D. grasshopper is frequently moulting
49. Complex social behaviour and organization are found mostly in
A. insects B. birds C. reptiles D. mammals
50. Which of the following structural features are adapted for uses other than water conservation?
A. Succulent stems B. Scales in animals
C. Spines in plants D. Feathers in birds

Biology 2001

1. An association between the root nodule of a leguminous plants and rhizobium sp is known as
A. commensalism B. mycorrhiza C. parasitism
D. symbiosis
2. Amphibians are normally found
A. on dry land and in water B. in water and on moist land
C. on moist land D. in water
3. Viviparity occurs mainly in the
A. mammals B. reptiles C. aves D. amphibians
4. The jointed structure in insects that bears organs which are sensitive to touch, smell and vibration is the
A. maxilla B. labium C. antenna D. abdomen
5. Which of the following groups is the most advanced?
A. Pteridophytes B. Bryophytes
C. Thallophytes D. Gymnosperms
6. Most monocots are easily recognized by their
A. short leaves with petioles B. long and sword-like leaves
C. long and palm-like leaves
D. short leaves with many veinlets

7. Water fleas, wood lice and barnacles belong to the group
A. arachnida B. crustacea C. insecta D. chilopoda
8. The mode of feeding in Amoeba and Hydra is
A. heterotrophic B. holophytic C. autotrophic D. symbiotic
9. Which of the following organisms does not exist as a single free living cell?
A. Paramecium B. Volvox C. Amoeba D. Chlamydomonas

Use the diagram below to answer questions 10 and 11

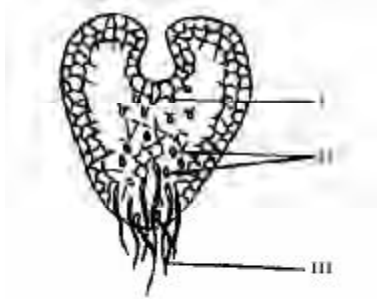

10. The structures labelled II and III respectively are
A. female organs and rhizoid B. male organs and rhizoid C. sporophyte and sori D. annulus and stalk of sporangium
11. In ferns, the structure above is equivalent to the
A. zygote of a moss B. gametophyte generation of a moss C. sporophyte generation of a moss D. sporophyte of a moss
12. The centre for learning and memory in the human brain is the
A. medulla oblongata B. cerebellum C. cerebrum D. olfactory lobe
13. Urea formation occurs in the
A. heart B. liver C. lung D. kidney

Use the diagram below to answer questions 14 and 15

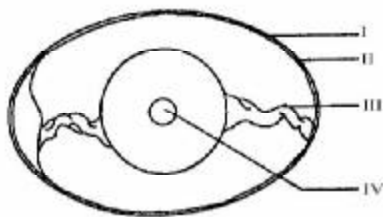

14. The structure that holds the yolk in position is labelled
A. II B. I C. IV D. III
15. The part labelled IV is the
A. albumen B. germinal disc C. sturdy D. stunted
16. The gas produced during tissue respiration can be identified by using
A. calcium hydroxide B. copper sulphate C. calcium carbonate D. sodium hydroxide
17. A seedling grown in the dark is likely to be
A. etiolated B. dormant C. sturdy D. stunted

18. The enzyme invertase will hydrolyze sucrose to give
A. maltose and glucose B. glycerol and fatty acid C. glucose and fructose D. mannose and galactose
19. When yeast respire anaerobically, it converts simple sugar to carbon (IV) oxide and
A. oxygen B. acid C. alcohol D. water
20. The transportation of oxygen and carbon (IV) oxide in mammals is carried out by
A. leucocytes B. thrombocytes C. phagocytes D. erythrocytes
21. The veins of the leaf are formed by the
A. vascular bundles B. cambium cells C. palisade tissue D. spongy mesophyll

Use the diagram below to answer questions 22 and 23

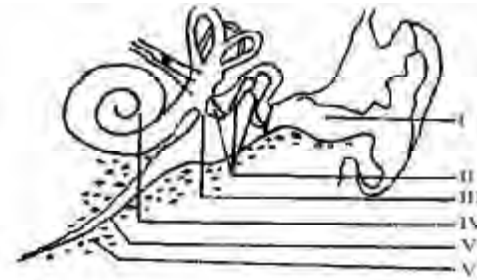

22. The parts which function together to bring about hearing are labelled.
A. IV, V and VI B. I, II, IV and VI C. I, II, III and IV D. I, II and IV
23. The part labelled II is the
A. fenestra ovalis B. middle ear canal C. internal auditory meatus D. ear ossicles
24. When specimen X is mixed with few drops of iodine solution, the appearance of a blue-black colour confirms that X is
A. Galactose B. Starch C. Sucrose D. Glucose

Use the diagram below to answer question 25 and 26

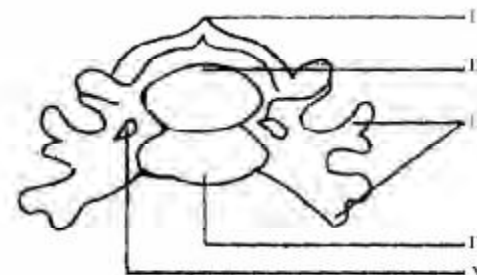

25. The structure above represents a
A. caudal vertebra B. lumbar vertebra C. thoracic vertebra D. cervical vertebra
26. Blood vessels usually pass through the structure labelled
A. III B. II C. V D. IV
27. Salts and water are absorbed in the roots and transported to the leaves by

- A. diffusion through the xylem tissues B. osmosis through the phloem tissues C. diffusion through the phloem tissues D. osmosis through the xylem tissues
28. The number of plant species obtained from a population study of a garden is as follows: Guinea grass (15), Ipomoeas SSP, (5), sida spp (7) and Imperata spp (23) What is the percentage of occurrence of Imperat, q spp?
A. 35% B. 16% C. 46% D. 23%
29. Carbon (IV) oxide content of the atmosphere is least affected by
A. cutting down and clearing of forest B. forest fires C. burning of fossil fuels D. plant and animal respiration
30. The factor that least affects food shortages in sub-Saharan Africa is
A. flooding B. pests C. mixed-cropping D. drought
31. The epiphytic habitat can best be described as
A. arboreal B. estuarine C. aquatic D. terrestrial
32. The highest percentage of energy in an ecosystem occurs at the level of the
A. secondary consumers B. decomposers C. producers D. primary consumers
33. The greatest influence on a stable ecosystem in nature is exerted by
A. man B. pollution C. animals D. rainfall
34. A freshwater pond may contain
A. tadpole, water boatman, leeches and crab
B. water beetle, shrimps, water snail and water bug
C. water lily, fish, water scorpion and dragontly larva
D. pond skater, water lily, shark and mosquito larva
36. The hygrometer is used for measuring
A. relative humidity B. specific gravity C. rainfall D. salinity
37. The distribution of plants in a rain forest is governed mainly by
A. vegetation B. soil types C. amount of sunlight D. rainfall pattern
38. Both recessive and dominant characters are found
A. on different chromosomes in the cell
B. at the same locus of a homologous chromosome
C. mother's sex cell D. mother's X chromosome
39. The probability of a baby being a boy or a girl depends on the condition of the
A. father's sex cell B. father's somatic chromosome C. mother's sex cell D. mother's X chromosome
40. Which of the following statements is true of blood groups and blood transfusion?
A. Group O is the universal recipient
B. Group A can donate to group A only
C. Group AB is the universal recipient
D. Group B can donate to group B only
41. Which of the following is likely to encourage inbreeding in plants
A. Dioecious B. Protandrous C. Monoecious D. Hermaphrodite
42. A tall plant crossed with a dwarf on produces offspring of which half are tall and half are dwarf what are the genotypes of the parents?
A. TT, TT B. Tt, Tt C. TT, tt D. Tt, Tt
43. In man, the ability to roll the tongue is a variation classified as
A. anatomical B. physiological C. structural D. morphological
44. Darwin is considered the first scientist who correctly explained the theory of
A. special creation B. spontaneous generation C. use and disuse D. organic evolution
45. The stem of a typical aquatic plant usually has many
A. air cavities B. intercellular spaces C. water cavities D. water-conducting cells.
46. The role of the male adult honey bee is to
A. clean the hive B. ventilate the hive C. mate with the queen D. care for the young
47. The ability of an organism to live successfully in an environment is known as
A. resistance B. competition C. succession D. adaptation
48. The most important adaptation of xerophytes is the ability of the protoplasm to
A. resist being damaged by loss of water
B. store sugar and minerals in the vacuoles
C. absorb water and swell
D. shrink from the cell wall
49. A green snake in green grass is able to escape notice from predators because of its
A. disruptive colouration B. countershiping C. warning colouration D. cryptic colouration
50. For heterotrophic organisms, competition is leas caused by the inadequacy of
A. mates B. space C. light D. nutrients

Biology 2002

- An Amoeba and an unlaidd chicken eggs are
A. animal tissues B. organelles C. single cell
D. organisms
- In corns food is usually stored in the
A. leaves B. stems C. roots D. buds
- The animals that move by means of flagella include
A. Chlamydomonas and Euglena B. Planaria and
Amoeba C. Amoeba and Hydra D. Paramecium and
Planaria
- The structures found only in plant cells are
A. cell membrane and cytoplasm B. chromatin and
nucleolus C. cell wall and chloroplast
D. cell membrane and lysosome
- A flower that has both stamens and pistil is said to be
A. staminate B. pistillate C. perfect D. imperfect
- When oil is poured into the breeding site of mosquitoes, it
A. deprives the larvae of water B. kills the adults
C. suffocates the pupae D. slows down egg
development.

Use the diagram below to answer questions 7 and 8

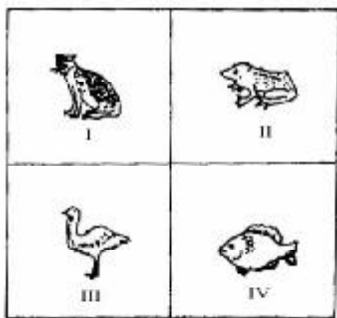

- The correct evolutionary sequence of the organisms represented is
A. I à III à II à IV B. II à III à IV à I C. III à II à IV à I
D. IV à II à III à I
- Ovoviparity is the type of fertilization exhibited by the organism labelled
A. I B. II C. III D. IV

Use the diagram below to answer questions 9 and 10

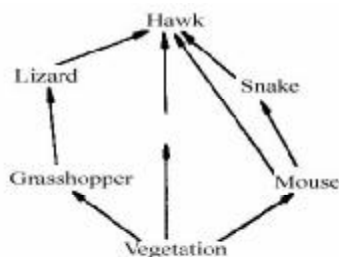

- In the diagram, the hawk is
A. an omnivore B. a primary consumer
C. a tertiary consumer D. a scavenger

- Example of competitors are
A. lizard and mouse B. snake and lizard
C. grasshopper and mouse D. rabbit and snake
- One of the adaptations to life on trees by a monkey is its possession of digits which are
A. extensible B. big C. opposable D. long
- The community of plants in which the same species occur from year to year is the
A. annual species B. pioneer vegetation
C. perennial species D. climax vegetation
- The most common means of transmitting Acquired Immune Deficiency Syndrome (AIDS) is
A. from mother to child B. through blood transfusion
C. through sexual intercourse D. through the sharing of needles
- Plants tend to prevent overcrowding by means of efficient
A. water uptake B. seed germination
C. pollination D. seed dispersal
- The physical and climatic factors of a region primarily determine the
A. kinds of animals inhabiting the area B. types of plants found in the area
C. nature of the soil in the region D. community of organisms in the region
- A step in the movement of energy through an ecosystem is a description that best fits the term
A. food chain B. trophic level C. pyramid of numbers
D. food web
- In a field experiment the frequency of waterleaf was observed to be 48 after 20 tosses of a 2m² quadrant. What is the density of the plant in the field?
A. 1.2per m² B. 2.4per m² C. 4.8per m²
D. 9.6per m²
- The supporting tissue of xylem is most poorly developed in
A. mangrove swamp plants B. grassland plants
C. submerged water plants D. desert plants
- The addition of lime to clay soil serve to
A. aid water retention B. close up the texture
C. prevent water-logging D. improve capillary action
- The excessive use of agro-chemicals could lead to the pollution of
A. the lithosphere B. the atmosphere
C. fresh water D. space
- In a population study using the transect method, a student is likely to record the highest number of species in
A. a tropical rain forest B. a guinea savanna
C. a sahel savanna D. an estuarine swamp

22. In his theory of evolution, Darwin implied that
 A. the struggle for existence among living organisms is sporadic
 B. the most successful organisms are those that best adapt to their environment
 C. organs of the body which are not regularly used by an organism will disappear
 D. any traits acquired by an organism during its lifetime can be passed on to its offspring
23. The carnassial teeth of a carnivorous animal consists of the
 A. last upper premolar and the first lower molar
 B. last upper molar and the last lower molar
 C. first upper premolar and the first lower molar
 D. first upper molar and the first lower molar
24. A feature of the caste systems of bees and termites is that
 A. the workers are sterile B. the kings are bigger than the queens C. only the worker perform duties
 D. nuptial fight is performed by all members
25. The structure that is common in the embryos of mammals, amphibians, birds, fishes and reptiles and which is an evidence of their common ancestry is the
 A. eye B. chorion C. allantois B. gillslits
26. Animals are restive when the environment in which they live becomes
 A. hot and dry B. cold and wet C. warm and humid
 D. windy and snowy
27. Birds which are large with long straight pointed beaks, long necks and long legs are likely to be
 A. insect eaters B. fish catchers C. nectar feeders
 D. fruit eaters
28. Examples of organisms in which extracellular digestion occurs are
 A. Fungus, Loranthus and housefly
 B. Rhizopus, sponges and earthworm C. Roundworm, tapeworm and Hydra
 D. Rhizopus, housefly and Hydra
29. The mammalian erythrocytes differ from erythrocytes are
 A. discoid and nucleated B. discoid and enucleated
 C. amoeboid and nucleated D. amoeboid and enucleated
30. The presence of endoskeleton is characteristic of
 A. invertebrata B. vertebrata C. insecta
 D. coelenterata
31. The capture and digestion of insects by a pitcher plant is a special form of nutrition termed
 A. autotrophic B. heterotrophic C. chemosynthetic
 D. saprophytic

Use the diagram below to answer questions 32 and 33

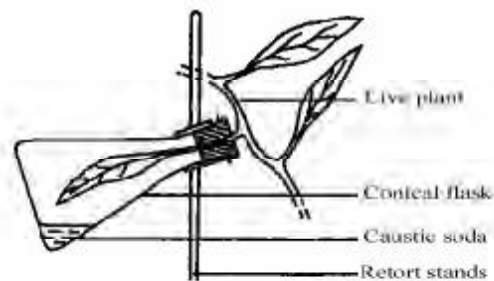

32. Which of the following statements is correct about the experiment?
 A. The flask must be of the conical type
 B. Caustic soda can be replaced with distilled water
 C. The enclosed leaf will lose its green colour
 D. The leaves outside the flask serve as control
33. The experimental set-up can be used to demonstrate that
 A. light is necessary for photosynthesis
 B. oxygen is necessary for photosynthesis
 C. photosynthesis occurs in the leaves of plants
 D. carbon (IV) oxide is necessary for photosynthesis
34. When a marine fish was taken from the ocean and put in a tank of fresh water, it died after a short period because
 A. the tank was too small compared to the large ocean
 B. the body cells of the fish swelled and burst as a result of the hypotonic fresh water
 C. the body cells of the fish shrank as their sap was hypertonic to be fresh water
 D. there was no food in the tank, so the fish starved
35. Which of the following pairs of organs is located in the anterior half of the mammalian body cavity?
 A. Kidneys and lungs B. Heart and ovary
 C. Lungs and hearts D. Kidneys and heart
36. The mode of nutrition exhibited by a tapeworm is
 A. symbiotic B. saprophytic C. parasitic D. holozoic
37. The organ located within the duodenal loop in the mammal is the
 A. spleen B. pancreas C. liver D. gall bladder
38. In which of the following groups of fruits is the pericarp inseparable from the seed coat?
 A. Nut B. Follicle C. Cypsela D. Cryopsis
39. A person that is obese must avoid meals containing
 A. carrots and oranges B. margarine and butter
 C. beef and beans D. rice and yam
40. Tissue respiration is important for the
 A. absorption of oxygen into the alveoli
 B. release of carbon (IV) oxide into the lungs
 C. release of energy for body use
 D. exhalation of carbon (IV) oxide from lungs.

Use the diagram below to answer question 41 and 42

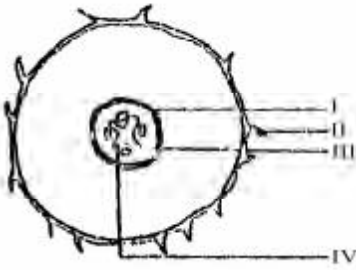

41. The structure labelled I represents the _____ the _____
A. I B. II C. III D. IV

42. The structure labelled I represents the _____
A. phloem B. xylem C. cortex D. pericycle

Use the diagram below to answer questions 43 and 44

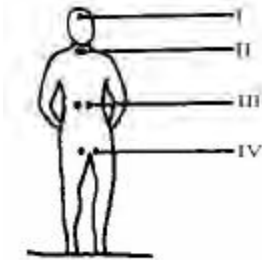

43. The gland usually found in the position labelled is the _____
A. adrenal B. thyroid C. pancreatic D. pituitary

44. A hormone secreted at IV serves to _____
A. facilitate the development of facial hairs
B. raise the level of calcium ions in the blood
C. lower blood glucose level
D. make the body react to emergencies

45. To select and retain the desirable trait of large body size with farmer has observed in his herd, the farmer needs to _____
A. feed the animals in the herd with more food
B. cross-breed his animals with a different herd
C. inbreed the animals in his herd
D. prevent diseases in his herd

46. In a population of living things, the parameters of size, height, weight and colour are example of _____
A. discontinuous variations B. continuous variations
C. physiological variations D. non-heritable variations

47. If X^N is the dominant allele for normal vision and X^n the recessive allele for colour-blindness, a boy with the genotype YX^n will _____
A. have normal vision B. be colour-blind
C. be totally blind D. be a carrier of colour-blindness

48. The first four children of a couple were all girls. The probability that the fifth will also be a girl is _____
A. $1/5$ B. $1/4$ C. $1/3$ D. $1/2$

49. Genetic counselling is important when a marriage is planned between a _____
A. Rh woman and Rh man B. Rh woman and Rh man
C. Rh woman and Rh man D. Rh woman and Rh man

50. What proportion of the offspring of a cross between two heterozygous parents will exhibit the recessive condition phenotypically?
A. $1/4$ B. $1/2$ C. $3/4$ D. $4/4$

Biology 2003

1. The umbrella-shaped fruiting body of a fully developed mushroom is the _____
A. mycelium B. basidium C. pileus D. stipe



Use the diagram above to answer question 2 and 3.

2. The processes of water loss and intake indicated by the arrows labelled I and II are respectively _____
A. evaporation and osmosis B. exhalation and osmosis
C. osmosis and diffusion D. urination and diffusion

3. A noticeable adaptation of the animal to its aquatic habitat is the possession of _____
A. webbed digits B. four limbs C. a wide mouth
D. large eyes

4. The similarity among organisms belonging to the same group will be least within each _____
A. order B. family C. species D. kingdom

5. Hermaphroditic reproduction can be found among the _____
A. annelids and molluscs B. pisces and amphibians
C. coelenterates and platyhelminthes D. arthropods and nematodes

6. One distinctive feature in the life history of liverworts is that they exhibit _____
A. vegetative reproduction B. alternation of generation
C. sexual reproduction D. asexual reproduction

Use the diagram above to answer questions 7 and 8

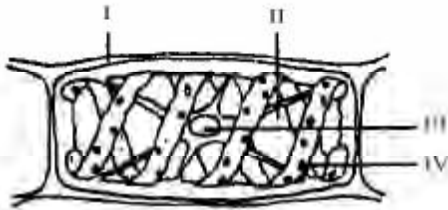

7. Food is stored in the structure labelled
A. III B. IV C. I D. II
8. The structures that are common to both plant and animal cell are labelled
A. II and III B. III and IV C. IV and I D. I and II
9. The cell component that is present in a prokaryotic cell is the
A. ribosome B. mitochondrion C. chloroplast
D. nuclear envelope
10. In the egg of a bird, the embryo is located in the
A. yolk B. embryo disc C. chalaza D. albumen
11. An insect whose economic importance is both harmful and benefit is the
A. butterfly B. mosquito C. blackfly D. tsetsefly

Use the diagram below to answer question 12 and 13.

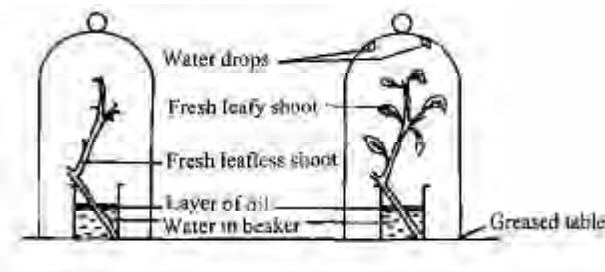

12. The experiment is used to demonstrate that
A. transpiration occurs through the leaves B. plants lose water through guttation C. leaves are important to photosynthesis D. water is necessary for photosynthesis
13. In the experiment, the layer of oil serves to prevent water loss by
A. Osmosis B. Transpiration C. Evaporation
D. Guttation
14. If water that has been coloured red is poured at the base of a wilting plant, it will appear as a red stain in the cells of the
A. phloem B. parenchyma C. xylem D. epidermis
15. The stunted growth of a leguminous plant suffering from nitrogen deficiency may be corrected by inoculating the soil with
A. saprophytic bacteria B. rhizobium
C. denitrifying bacteria D. nitrosomonas

16. Organisms I, II, III and IV have surface/volume ratios of 1:2, 1:3, 1:4 and 1:5 respectively. The organism that is likely to have the most complex transport system is
A. III B. IV C. II D. I

Use the diagram below to answer questions 17 and 18

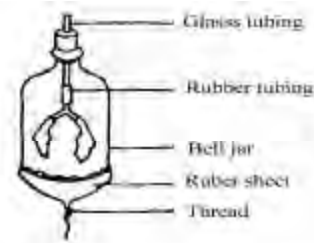

17. The aim of the experiment is to demonstrate
A. the presence of carbon (IV) oxide in exhaled air
B. that in mammals gaseous exchange take place in the lungs
C. the part played by the pleural cavity and diaphragm in respiration D. that a large amount of oxygen is absorbed by the lungs.
18. In the experimental set-up, the rubber sheet represents the organ called
A. diaphragm B. lungs C. intercostal D. pleural cavity
19. The part of the mammalian digestive system where absorption of nutrients takes place is the
A. duodenum B. colon C. ileum D. oesophagus
20. The dark reaction of photosynthesis involves the
A. release of oxygen and the splitting of water
B. photolysis of water and the production of starch
C. reduction of carbon (IV) oxide to organic compounds
D. splitting of water into hydrogen ions
21. The most important hormone that induces the ripening of fruit is
A. Cytokinin B. Indole acetic acid C. Ethylene
D. Gibberellin
22. Metabolic production of urea is carried out in the
A. urinary bladder and kidney B. pancreas
C. kidney and malphigian tubule D. liver
23. In mammalian males, the excretory and reproductive system share the
A. ureter B. testes C. vas deferens D. urethra
24. The best method of propagating sugarcane is by
A. stem cuttings B. seed sowing C. layering
D. grafting
25. The response of plants to external stimuli in a non-directional manner is known as
A. nastic movement B. phototropism C. tactic
D. geotropism

Use the diagram below to answer questions 26 and 27



26. The structure can be found in the
 A. peripheral and central nervous systems
 B. peripheral nervous system only
 C. sympathetic and parasympathetic nervous systems
 D. central nervous system only
27. The point marked I is referred to as
 A. myelin sheath B. dendrites C. node of Ranvier
 D. axon
28. Homologous pairs of chromosomes separate during
 A. meiosis B. cytolysis C. mitosis D. cleavage
29. An example of a caryopsis is
 A. coconut B. tomato C. guava D. maize grain
30. A limiting factor in a plant population near a chemical factory is likely to be
 A. humidity B. pH C. wind D. light
31. The pioneer organisms in ecological succession are usually the
 A. lichens B. algae C. ferns D. mosses
32. Mycorrhiza is an association between fungi and
 A. roots of higher plants B. filamentous algae
 C. bacteria D. protozoans
33. A density-dependent factor that regulates the population size of organisms is
 A. sudden flood B. disease C. fire outbreak
 D. drought
34. The most effective method of dealing with non-biodegradable pollution is by
 A. burying B. dumping C. incineration
 D. recycling
35. Soil fertility can best be conserved and renewed by the activities of
 A. microbes B. earthworms C. man D. rodents
36. The correct sequence of biomes from northern to southern Nigeria is
 A. estuarine → tropical rain forest → guinea savanna → sahel savanna
 B. sahel savanna → sudan savanna → guinea savanna → tropical rainforest → estuarine
 C. sahel savanna → tropical rain forest → estuarine → guinea savanna
 D. guinea savanna → sudan savanna → tropical rainforest → sahel savanna → estuarine
37. One example of fossil fuels is
 A. coral B. limestone C. firewood D. coal
38. If the pair of alleles for baldness is given as Bb, a female carrier will be denoted by
 A. $X^B X^b$ B. $X^B X^B$ C. $X^b Y$ D. $X^B Y$
39. An organism that has been extensively used to test the chromosome theory of heredity is
 A. Homo sapiens B. Drosophila melanogaster
 C. Zea Mays D. Musea domestica
40. A feature associated with the Y-chromosome in humans is
 A. facial hairs B. prominent fingernails
 C. long eyelashes D. enlarged breast
41. A man and his wife are both heterozygous for the sickle-cell trait. The likely percentage of their offspring that will be either carriers or sicklers is
 A. 50% B. 25% C. 75% D. 100%
42. The type of reproduction that leads to variation in animal and plant populations is
 A. budding B. vegetative C. asexual D. sexual
43. If a DNA strand has a base sequence TCA, its complementary strand must be
 A. ATG B. GAT C. AGT D. TAG
44. Which of the following requires the use of carbon dating to prove that evolution has occurred?
 A. biochemical similarities B. molecular records
 C. fossil records D. comparative anatomy
45. The presence of sunken stomata and the folding of leaves are adaptations to
 A. prevent entry of pathogens B. prevent guttation
 C. remove excess water D. reduce water loss
46. Spines and shells on animals are adaptations for
 A. physical defence B. camouflage C. chemical defence
 D. mimicry
47. The inactive state exhibited by an animal during hot dry seasons is termed
 A. aestivation B. dormancy C. resting D. hibernation
48. An insect with a mandibulate mouth part will obtain its food by
 A. chewing B. chewing and sucking C. sucking
 D. biting and chewing
49. An example of cryptic colouration is the
 A. bright marks on a poisonous tropical frog on variegated leaves
 B. bright colour of an insect-pollinated flower
 C. mottled colours on moths that rest on lichens
 D. green colour of a plant
50. An argument against Lamarck's theory of evolution is that
 A. acquired traits cannot be passed onto the offspring
 B. disuse of body part cannot weaken the part
 C. disused part is dropped off in the offspring
 D. traits cannot be acquired through constant use of body parts.

Biology 2004

- The gall bladder of a mammal has a duct connected to the
A. duodenum B. liver C. pancreas D. small intestine
- The opening of the stoma is controlled by the
A. presence of guard cells B. decrease in solute concentration in the guard cells C. increase in solute concentration in the guard cells
D. presence of a pore.

Use the diagram below to answer questions 3 and 4

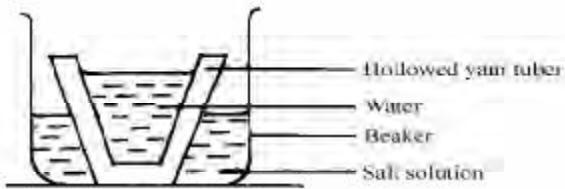

- Yam is used in this set-up because it
A. act as a semi-permeable membrane B. act as a storage organ C. is permeable to the salt solution
D. is a plant material
- Which of the following results is to be expected if the set-up is left for several hours?
A. Movement of water from the salt solution B. Decrease in the size of the yam C. Movement of the salt solution into the water D. Decrease in the volume of water inside the yam.
- The eggs of birds contain relatively larger quantities of yolk than those of amphibians and reptiles because
A. embryonic development is longer in birds B. birds lay shelled eggs C. birds are generally bigger in size D. those of birds are fertilized internally.
- In the internal structure of plants, a wide pith in the centre is common to
A. dicot root and monocot stems B. dicot stems and monocot stems C. dicot stem and monocot roots
D. dicot roots and monocot roots.
- If a nursing mother is not producing enough milk, her hormonal system is probably deficient in
A. testosterone B. thyroxin C. insulin D. prolactin

Use the diagram below to answer questions 8 and 9

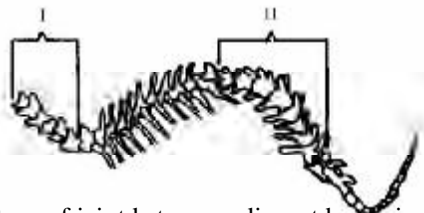

- The type of joint between adjacent bones in the part labelled II is the
A. hinge joint B. suture joint C. sliding joint
D. ball-and-socket joint

- The bones labelled II are called
A. thoracic vertebrae B. lumbar vertebrae C. cervical vertebrae D. sacral vertebrae.
- The breakdown of fats and oils into simpler absorbable compounds is catalyzed by the group of enzymes called
A. peptidases B. amylases C. lipases D. hydrolases
- The two key cations involved in the action potential of nervous transmissions are
A. Mg^{2+} and K^{+} B. Na^{+} and Fe^{2+} C. Fe^{2+} and Mg^{2+}
D. Na^{+} and K^{+}

Use the diagram below to answer questions 12 and 13

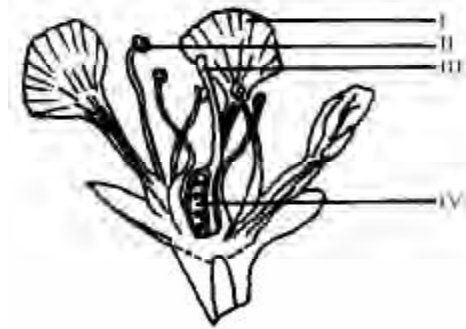

- The part labelled II is the
A. anther B. style C. filament D. stigma
- The process of pollination involves the transfer of pollens from
A. III to IV B. IV to I C. II to III D. I to II
- The anaerobic fermentation of a glucose molecule yields
A. pyruvic acid and alcohol B. 38 ATP molecules
C. water and carbon (IV) oxide D. 2ATP molecules and alcohol

Use the diagram below to answer questions 15 and 16

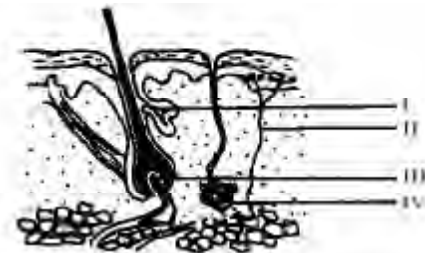

- The function of the part labelled III is to
A. produce oil for the skin B. carry blood and nitrogenous waste C. contract to pull the hair erect
D. conduct nervous impulses
- The sweat gland is the structure labelled
A. IV B. III C. II D. I

17. The type of reproduction that is common to both Hydra and yeast is
A. grafting B. budding C. conjugation D. binary fission
18. Epigeal germination of a seed is characterized by
A. lack of growth of the hypocotyls B. more rapid elongation of the hypocotyls than the epicotyl
C. more rapid elongation of the epicotyl than the hypocotyl D. equal growth rate of both the hypocotyl and epicotyl.
19. All living cells require water because it
A. is a medium that neutralizes acids in cells
B. is the main source of energy for the cells
C. prevents the development of diseases in cell
D. is a medium for all metabolic reactions.
20. The surface of an alveolus in a mammals is well supplied with tiny blood vessels known as
A. capillaries B. arteries C. arterioles D. venules
21. Nervous control differs from hormonal control in that the former
A. is a slower process B. involves only chemical transmission C. has no specific pathway
D. produces short-term changes
22. Identical twins inherit their genes from
A. one egg and two sperms B. two eggs and a sperm
C. the same egg and sperm D. different eggs and sperms
23. Paternity disputes can most accurately be resolved through the use of
A. DNA analysis B. fingerprinting C. tongue-rolling
D. blood group typing
24. Sex-linked genes are located on
A. X-and Y-chromosomes B. homologous chromosomes
C. X- chromosomes D. Y- chromosome.
25. In a Mendelian cross of red and white varieties of the four o'clock plant, the F_1 generation expresses incomplete dominance by having flowers which are
A. multicoloured B. pink C. red D. white
26. Insects are considered the most successful among the invertebrates because they
A. survive in various environmental conditions
B. possess the ability to change their forms C. possess exoskeletons D. have wing for flight
27. The absence of special food and water-conducting systems restricts the body size in
A the bryophytes and the pteridophytes
B. the thallophytes and the pteridophytes C. liverworts, mosses and ferns D. algae, liverworts and mosses.
28. A peculiar characteristic of mammals is that they
A. have sebaceous glands B. have teeth C. are warm-blooded D. have lungs.

29. The rods in the retina of the eye are examples of
A. organs B. cells C. systems D. tissues
30. The larval stage of a mosquito is called
A. caterpillar B. maggot C. wriggler D. grub
31. The most common characteristic of the fungal hyphae is the possession of
A. cell-like partitions formed by cross-walls
B. cell-like compartments with one nucleus each
C. a multicellular mycelium in the substrate
D. cell walls that are both rigid and chitinous

Use the diagram below to answer question 32 and 33.

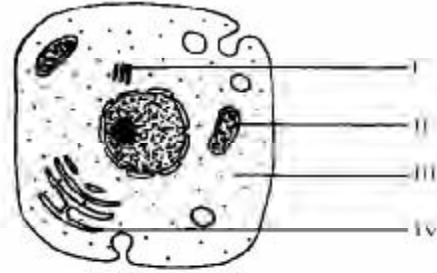

32. The part labelled II is responsible for
A. respiration B. protein synthesis C. excretion
D. photosynthesis
33. The endoplasmic reticulum is represented by the part labelled
A. III B. VI C. I D. II
34. The function of the long-winged reproductives in a termite colony is to
A. protect the young B. participate in swarming
C. feed the young D. disperse the population
35. A plant-like feature in *Euglena* is the
A. large vacuole B. gullet C. pellicle D. pigment spot
36. Which of the following is an example of intraspecific competition?
A. Yam and potato shoots growing out through the same window
B. A lizard and an ant-eater chasing an insect
C. A worker termite and a soldier in a limited space
D. A hawk and an eagle targeting the same chicken
37. The spots and stripes of the leopard and tiger are examples of
A. warning colouration B. countershading C. cryptic colouration
D. disruptive colouration
38. Rodents gnaw on food with their
A. strong jaws B. flat-ridged teeth C. chisel-like front teeth
D. molar teeth.
39. An evidence of the relationship between living organisms and their extinct relatives can best be obtained from
A. palaeontology B. embryology C. comparative anatomy
D. comparative physiology.

40. Plants survive hot dry conditions by
 A. producing numerous leaves B. having numerous stomata C. having evergreen leave D. storing water in large parenchyma cells.
41. A caterpillar and an aphid living in different parts of the same plant can be said to
 A. be in similar microhabitats B. occupy different ecological niches C. occupy the same ecological niche D. be in different habitats
42. The progressive loss of energy at each level in a food chain leads to
 A. a decrease in biomass at each successive level
 B. an increase in the number of organisms at each successive level C. an increase in the total weight of living matter at each successive level D. an increase in biomass at each successive level
43. The soil type that will be most difficult to plough in a wet season is one that is
 A. sandy B. loamy C. silty D. clayey
44. Which of the zones is likely to be a desert?
 A. III B. IV C. I D. II
45. High relative humidity will be expected in zones
 A. II and III B. II and IV C. I and IV D. I and III
46. One adaptation of reptiles to water loss is the presence of
 A. long tails B. long sticky tongues C. keratinous scales D. claws on limbs.
47. The scarcity of food causes a sudden decrease in population size by
 A. minimizing the rate of competition B. raising the mortality rate C. bringing about immigration D. decreasing the reproductive rate
48. The association between termites and the cellulose-digesting protozoan in their guts is an example of
 A. mutualism B. saprophytism C. commensalism D. parasitism
49. A state in Nigeria that is most susceptible to desert encroachment is
 A. Kaduna B. Kastina C. Kwara D. Taraba
50. A farm practice that results in the loss of soil fertility is
 A. continuous cropping B. mixed farming C. bush fallowing D. shifting cultivation.

Use the table below to answer questions 44 and 45

Ecological zone	Temperature (°C)	Rainfall (mm)
I	45	300
II	32	2 000
III	30	2 200
IV	15	800